

# EZ-ZONE<sup>®</sup> PM

## User's Manual



## PID Controller Models



**ISO 9001**



Registered Company  
Winona, Minnesota USA

1241 Bundy Boulevard., Winona, Minnesota USA 55987  
Phone: +1 (507) 454-5300, Fax: +1 (507) 452-4507 <http://www.watlow.com>

0600-0058-0000 Rev. G



November 2009

Made in the U.S.A.

## Safety Information







We use note, caution and warning symbols throughout this book to draw your attention to important operational and safety information.







A “NOTE” marks a short message to alert you to an important detail.

A “CAUTION” safety alert appears with information that is important for protecting your equipment and performance. Be especially careful to read and follow all cautions that apply to your application.

A “WARNING” safety alert appears with information that is important for protecting you, others and equipment from damage. Pay very close attention to all warnings that apply to your application.

The electrical hazard symbol, ⚡ (a lightning bolt in a triangle) precedes an electric shock hazard CAUTION or WARNING safety statement.

Symbol	Explanation
	CAUTION – Warning or Hazard that needs further explanation than label on unit can provide. Consult users manual for further information.
	ESD Sensitive product, use proper grounding and handling techniques when installing or servicing product.
	Unit protected by double/reinforced insulation for shock hazard prevention.
	Do not throw in trash, use proper recycling techniques or consult manufacturer for proper disposal.
	Enclosure made of Polycarbonate material. Use proper recycling techniques or consult manufacturer for proper disposal.
	Unit can be powered with either alternating current (ac) voltage or direct current (dc) voltage.
	Unit is a Listed device per Underwriters Laboratories®. It has been evaluated to United States and Canadian requirements for Process Control Equipment. UL 61010 and CSA C22.2 No. 61010. File E185611 QUYX, QUYX7. See: <a href="http://www.ul.com">www.ul.com</a>

	Unit is a Listed device per Underwriters Laboratories®. It has been evaluated to United States and Canadian requirements for Hazardous Locations Class 1 Division II Groups A, B, C and D. ANSI/ISA 12.12.01-2007. File E184390 QUZW, QUZW7. See: <a href="http://www.ul.com">www.ul.com</a>
	Unit is compliant with European Union directives. See Declaration of Conformity for further details on Directives and Standards used for Compliance.
	Unit has been reviewed and approved by Factory Mutual as a Temperature Limit Device per FM Class 3545 standard. See: <a href="http://www.fmglobal.com">www.fmglobal.com</a>
	Unit has been reviewed and approved by CSA International for use as Temperature Indicating-Regulating Equipment per CSA C22.2 No. 24. See: <a href="http://www.csa-international.org">www.csa-international.org</a>
	Unit has been reviewed and approved by ODVA for compliance with DeviceNet communications protocol. See: <a href="http://www.odva.org">www.odva.org</a>
	Unit has been reviewed and approved by ODVA for compliance with Ethernet/IP communications protocol. See: <a href="http://www.odva.org">www.odva.org</a>

## Warranty

The EZ-ZONE® PM is manufactured by ISO 9001-registered processes and is backed by a three-year warranty to the first purchaser for use, providing that the units have not been misapplied. Since Watlow has no control over their use, and sometimes misuse, we cannot guarantee against failure. Watlow’s obligations hereunder, at Watlow’s option, are limited to replacement, repair or refund of purchase price, and parts which upon examination prove to be defective within the warranty period specified. This warranty does not apply to damage resulting from transportation, alteration, misuse or abuse. The purchaser must use Watlow parts to maintain all listed ratings.

## Technical Assistance

If you encounter a problem with your Watlow controller, review your configuration information to verify that your selections are consistent with your application: inputs, outputs, alarms, limits, etc. If the problem persists, you can get technical assistance from your local Watlow representative (see back cover), by e-mailing your questions to [wintechsupport@watlow.com](mailto:wintechsupport@watlow.com) or by dialing +1 (507) 494-5656 between 7 a.m. and 5 p.m., Central Standard Time (CST). Ask for for an Applications Engineer. Please have the following information available when calling:

- Complete model number

- All configuration information
- User's Manual
- Factory Page

### **Return Material Authorization (RMA)**

1. Call Watlow Customer Service, (507) 454-5300, for a Return Material Authorization (RMA) number before returning any item for repair. If you do not know why the product failed, contact an Application Engineer or Product Manager. All RMA's require:
  - Ship-to address
  - Bill-to address
  - Contact name
  - Phone number
  - Method of return shipment
  - Your P.O. number
  - Detailed description of the problem
  - Any special instructions
  - Name and phone number of person returning the product.
2. Prior approval and an RMA number from the Customer Service Department is required when returning any product for credit, repair or evaluation. Make sure the RMA number is on the outside of the carton and on all paperwork returned. Ship on a Freight Prepaid basis.
3. After we receive your return, we will examine it and try to verify the reason for returning it.
4. In cases of manufacturing defect, we will enter a repair order, replacement order or issue credit for material returned. In cases of customer mis-use, we will provide repair costs and request a purchase order to proceed with the repair work.
5. To return products that are not defective, goods must be in new condition, in the original boxes and they must be returned within 120 days of receipt. A 20 percent restocking charge is applied for all returned stock controls and accessories.
6. If the unit is unrepairable, you will receive a letter of explanation. and be given the option to have the unit returned to you at your expense or to have us scrap the unit.
7. Watlow reserves the right to charge for no trouble found (NTF) returns.

The EZ-ZONE® PM PID Controller User's Manual is copyrighted by Watlow Winona, Inc., © November 2009 with all rights reserved.

EZ-ZONE® PM is covered by U.S. Patent No. 6,005,577 and Patents Pending



# Table of Contents

- Chapter 1: Overview . . . . . 2**
  - Standard Features and Benefits . . . . . 2
- Chapter 2: Install and Wire. . . . . 5**
- Chapter 3: Keys and Displays . . . . . 23**
- Chapter 4: Home Page. . . . . 25**
  - Conventions Used in the Menu Pages . . . . . 28
- Chapter 5: Operations Page . . . . . 30**
- Chapter 6: Setup Page . . . . . 41**
- Chapter 7: Profiling Page . . . . . 64**
- Chapter 8: Factory Page. . . . . 68**
- Chapter 9: Features . . . . . 74**
  - Using Lockout to Hide Pages and Menus. . . . . 85
  - Using Password Security . . . . . 86
- Chapter 10: Appendix . . . . . 88**
  - Troubleshooting Alarms, Errors and Control Issues. . . . . 88
  - Specifications . . . . . 91
  - Ordering Information for PID Controller Models . . . . . 93
  - Index. . . . . 94

# 1

## Chapter 1: Overview

The EZ-ZONE® PM takes the pain out of solving your thermal loop requirements.

Watlow's EZ-ZONE PM controllers offer options to reduce system complexity and the cost of control-loop ownership. You can order the EZ-ZONE PM as a PID controller or an over-under limit controller, or you can combine both functions in the PM Integrated Limit Controller. You now have the option to integrate a high-amperage power controller output, an over-under limit controller and a high-performance PID controller all in space-saving, panel-mount packages. You can also select from a number of serial communications options to help you manage system performance.

It just got a whole lot easier to solve the thermal requirements of your system. Because the EZ-ZONE PM controllers are highly scalable, you only pay for what you need. So if you are looking for a PID controller, an over-under limit controller or an integrated controller, the EZ-ZONE PM is the answer.

### Standard Features and Benefits

#### Advanced PID Control Algorithm

- TRU-TUNE+® Adaptive tune provides tighter control for demanding applications.
- Auto Tune for fast, efficient start ups

#### High-amperage Power Control Output

- Drives 15 amp resistive loads directly
- Reduces component count
- Saves panel space and simplifies wiring
- Reduces the cost of ownership

#### EZ-ZONE configuration communications and software

- Saves time and improves the reliability of controller set up

#### Parameter Save & Restore Memory

- Reduces service calls and down time

#### Agency approvals: UL Listed, CSA, CE, RoHS, W.E.E.E. FM

- Assures prompt product acceptance
- Reduces end product documentation costs
- Semi F47-0200

#### P3T Armor Sealing System

- NEMA 4X and IP66 offers water and dust resistance, can be cleaned and washed down
- Backed up by UL 50 independent certification to NEMA 4X specification

#### Three-year warranty

- Demonstrates Watlow's reliability and product support

#### Touch-safe Package

- IP2X increased safety for installers and operators

#### Removable cage clamp wiring connectors

- Reliable wiring, reduced service calls
- Simplified installation

#### EZ-Key/s

- Programmable EZ-Key enables simple one-touch operation of repetitive user activities

#### Programmable Menu System

- Reduces set up time and increases operator efficiency

#### Full-featured Alarms

- Improves operator recognition of system faults
- Control of auxiliary devices

#### Heat-Cool Operation

- Provides application flexibility with accurate temperature and process control

#### Profile Capability

- Preprogrammed process control
- Ramp and soak programming with four files and 40 total steps

## A Conceptual View of the PM

The flexibility of the PM's software and hardware allows a large range of configurations. Acquiring a better understanding of the controller's overall functionality and capabilities while at the same time planning out how the controller can be used will deliver maximum effectiveness in your application.

It is useful to think of the controller in three parts: inputs; procedures; and outputs. Information flows from an input to a procedure to an output when the controller is properly configured. A single PM controller can carry out several procedures at the same time, for instance closed-loop control, monitoring for several different alarm situations and operating switched devices, such as lights and motors. Each process needs to be thought out carefully and the controller's inputs, procedures and outputs set up properly.

### Inputs

The inputs provide the information that any given programmed procedure can act upon. In a simple form, this information may come from an operator pushing a button or as part of a more complex procedure it may represent a remote set point being received from another controller.

Each analog input typically uses a thermocouple or RTD to read the temperature of something. It can also read volts, current or resistance, allowing it to use various devices to read humidity, air pressure, operator inputs and others values. The settings in the Analog Input Menu (Setup Page) for each analog input must be configured to match the device connected to that input.

Each digital input reads whether a device is active or inactive. A PM with digital input-output hardware includes two sets of terminals each of which can be used as either an input or an output. Each pair of terminals must be configured to function as either an input or output with the Direction parameter in the Digital Input/Output Menu (Setup Page).

The Function or EZ Key on the front panel of the PM also operates as a digital input by toggling the function assigned to it in the Digital Input Function parameter in the Function Key Menu (Setup Page).

### Functions

Functions use input signals to calculate a value. A function may be as simple as reading a digital input to set a state to true or false, or reading a temperature to set an alarm state to on or off. Or, it could compare the temperature of a process to the set point and calculate the optimal power for a heater.

To set up a function, it's important to tell it what source, or instance, to use. For example, an alarm may be set to respond to either analog input 1 or 2 (instance 1 or 2, respectively).

Keep in mind that a function is a user-programmed internal process that does not execute any action outside of the controller. To have any effect outside of the controller, an output must be configured to respond to a function.

### Outputs

Outputs can perform various functions or actions in response to information provided by a function, such as operating a heater; turning a light on or off; unlocking a door; or turning on a buzzer.

Assign an output to a Function in the Output Menu or Digital Input/Output Menu. Then select which instance of that function will drive the selected output. For example, you might assign an output to respond to alarm 4 (instance 4) or to retransmit the value of analog input 2 (instance 2).

You can assign more than one output to respond to a single instance of a function. For example, alarm 2 could be used to trigger a light connected to output 1 and a siren connected to digital output 5.

### Input Events and Output Events

Input events are internal states that are set by the digital inputs. Digital input 5 provides the state of input event 1, and digital input 6 provides the state of input event 2. Wait for Event steps in profiles are triggered by these events. The setting of Digital Input Function (Setup Page, Digital Input/Output Menu) does not change the relationship between the input and the event, so take care not to configure the function in a way that would conflict with a profile that uses and input event. An input will still control the input event state, even if Digital Input Function is set to None.

Output events are internal states that can only be set by profile steps. Outputs 1 through 4 can be configured to respond to output events.



# EZ-ZONE® PM PID Model System Diagram

Universal Sensor Input, Configuration Communications,  
Red/Green 7-Segment Display

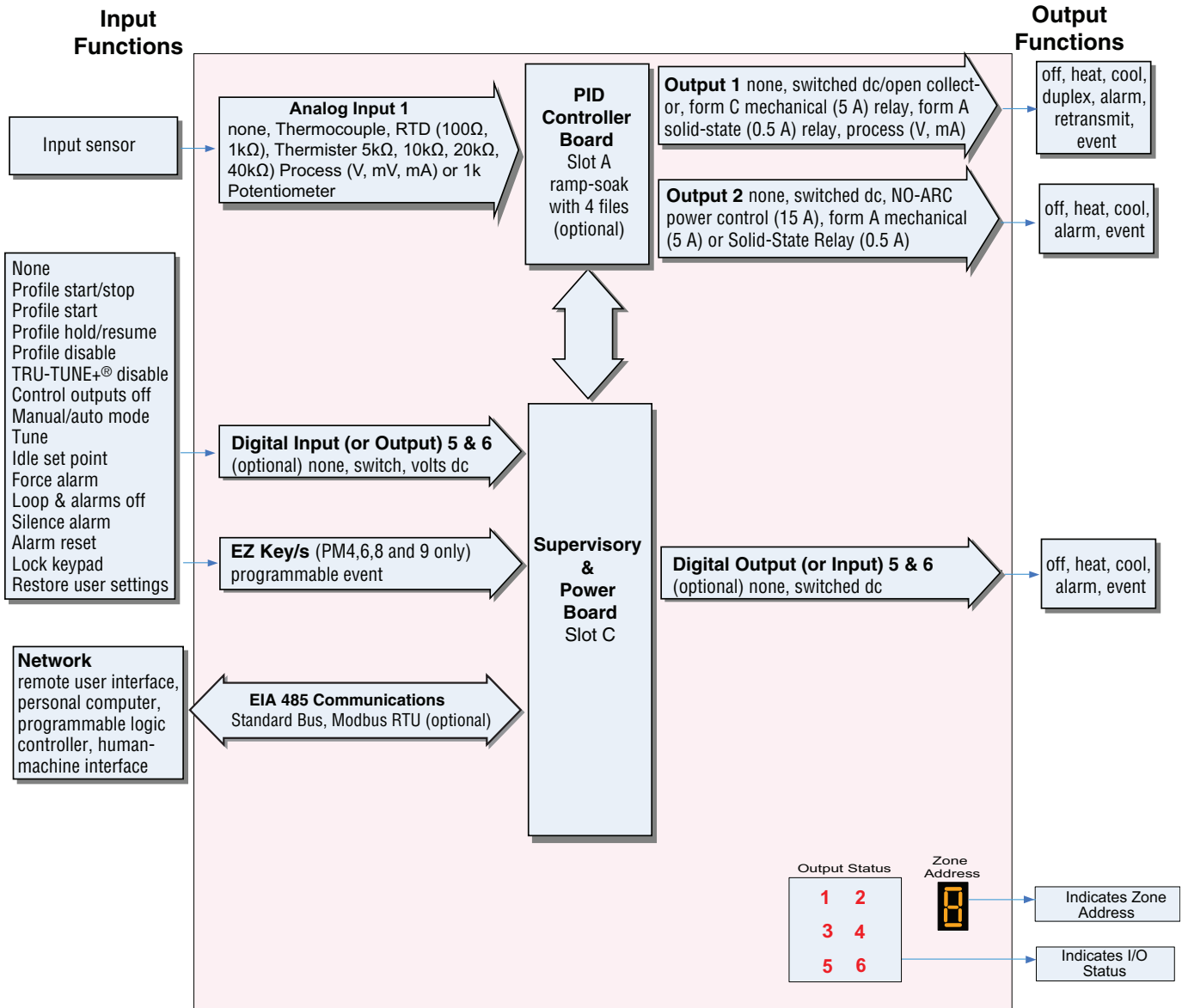

# 2 Chapter 2: Install and Wire

## Dimensions 1/32 DIN

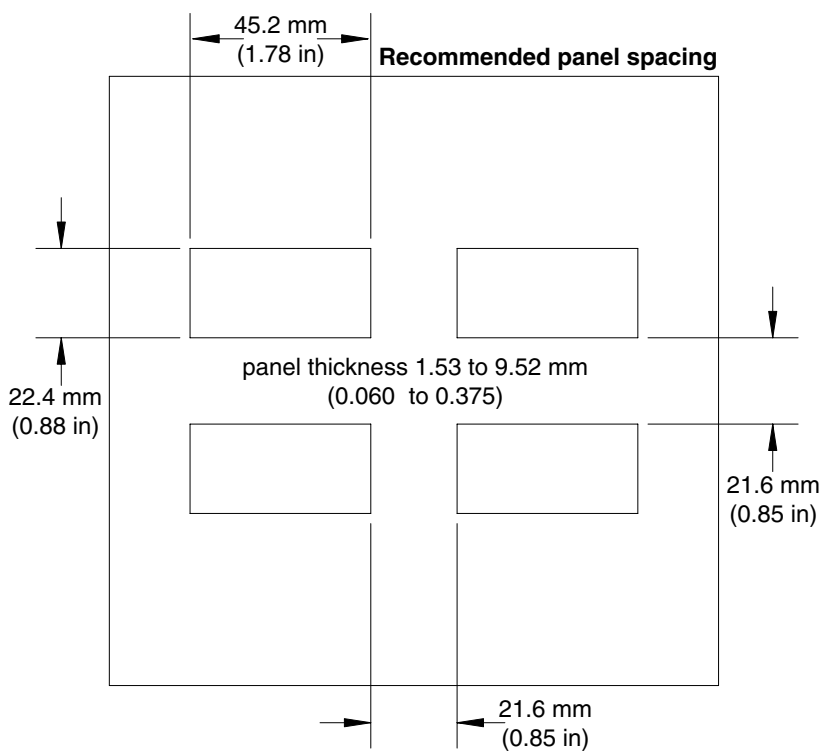
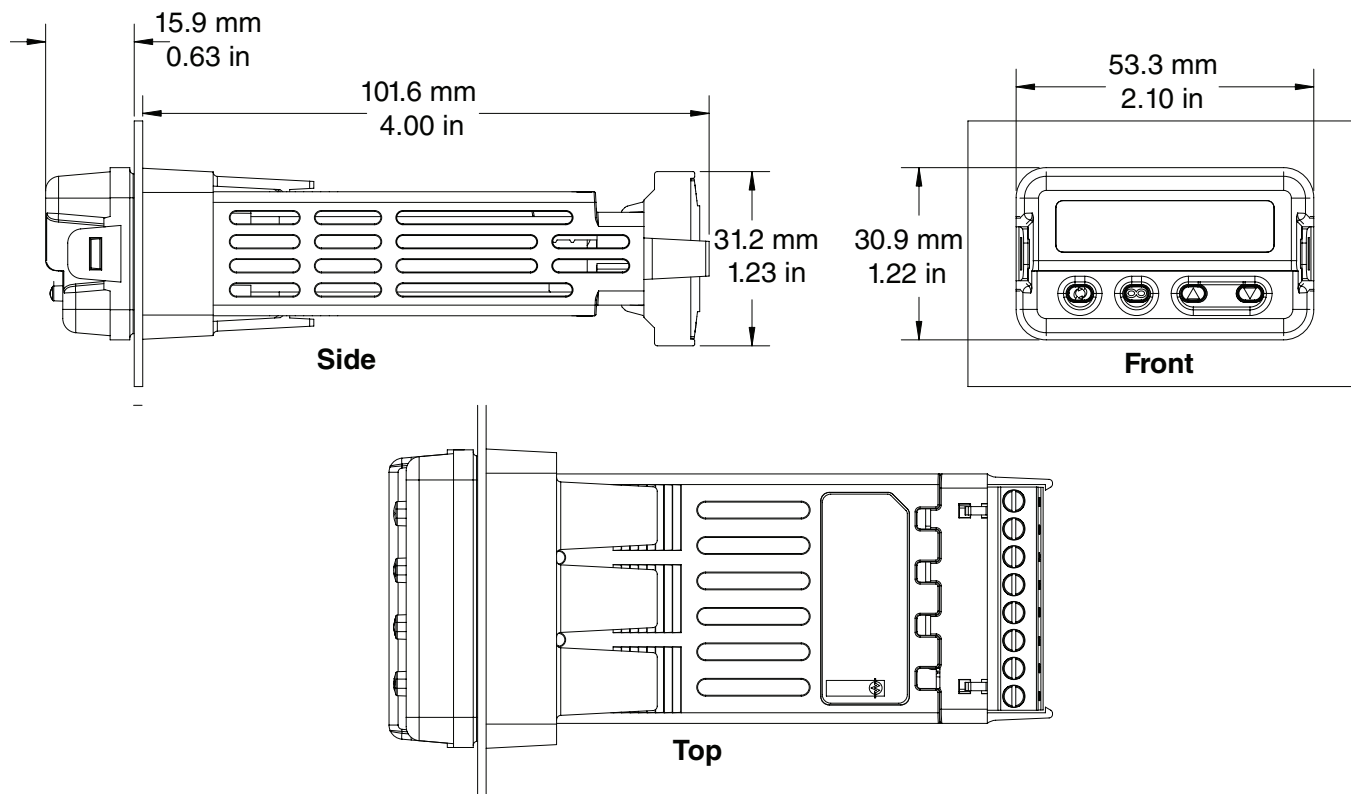



# Dimensions 1/16 DIN

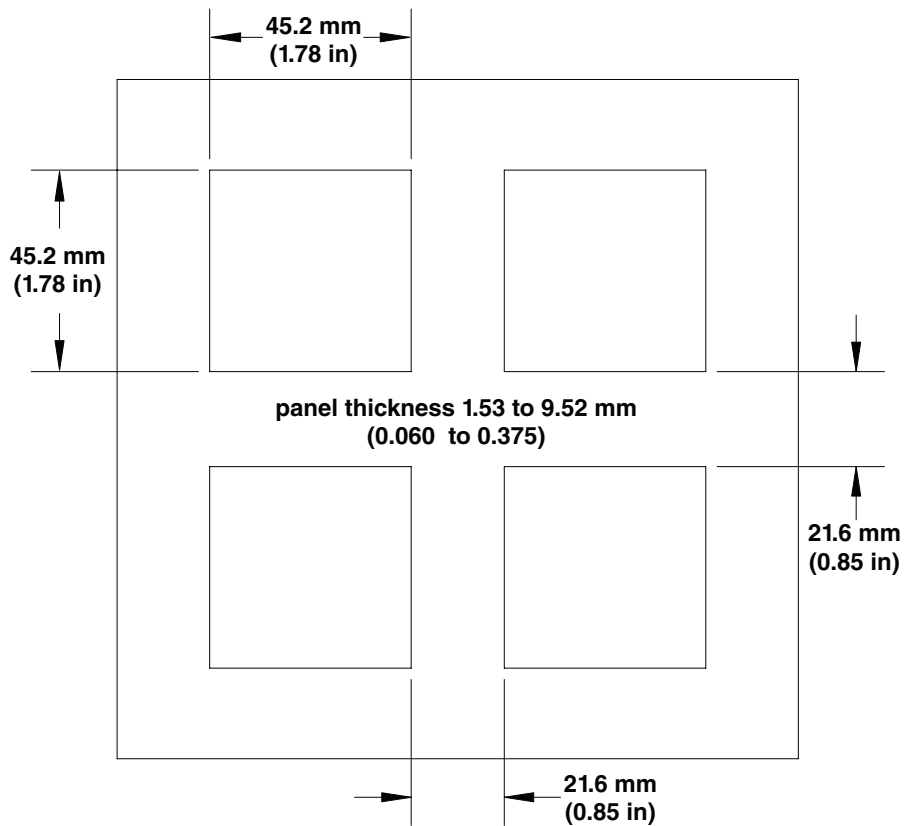
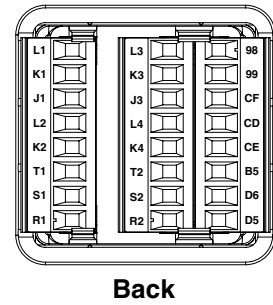
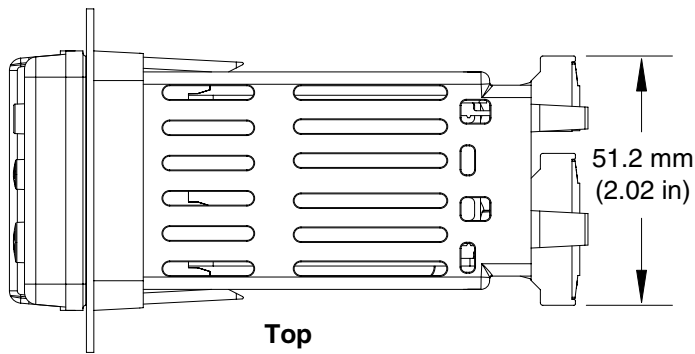
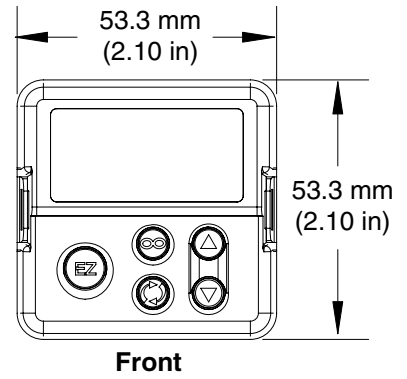
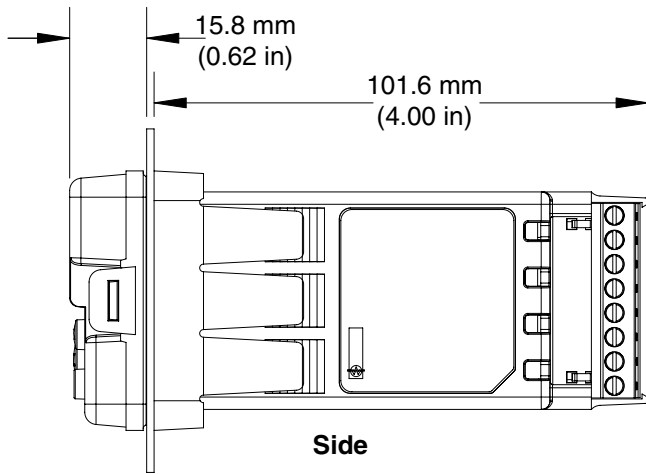

## 1/8 DIN (PM8) Vertical Dimensions

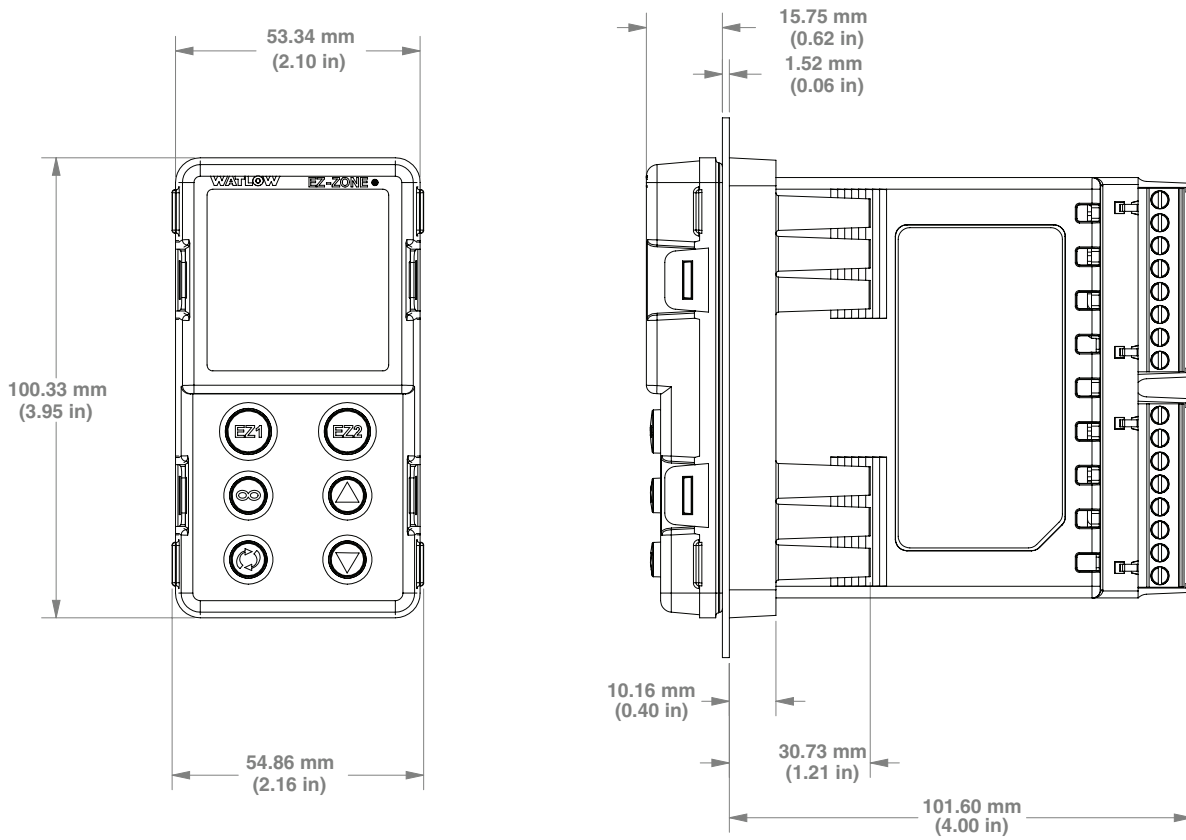

## 1/8 DIN (PM8) Vertical Recommended Panel Spacing

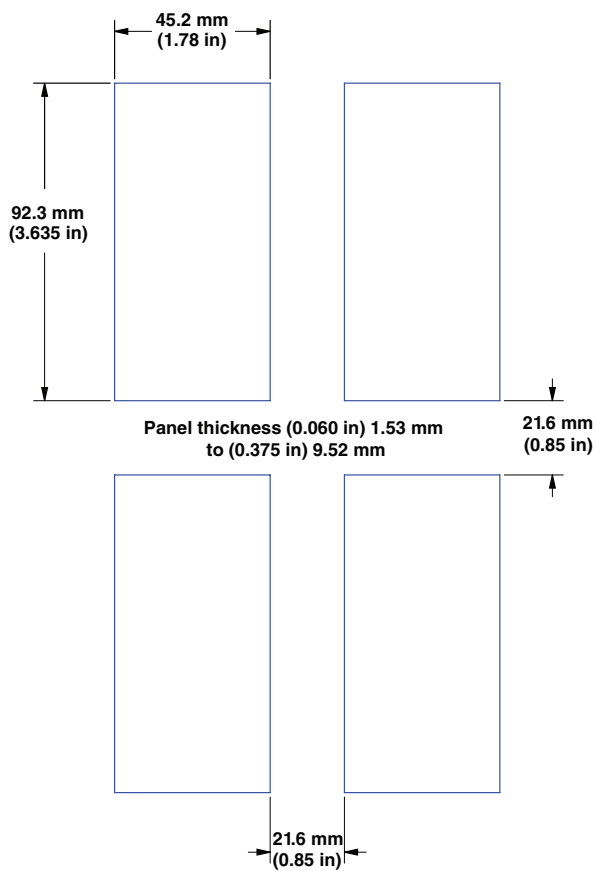

## 1/8 DIN (PM9) Horizontal Dimensions

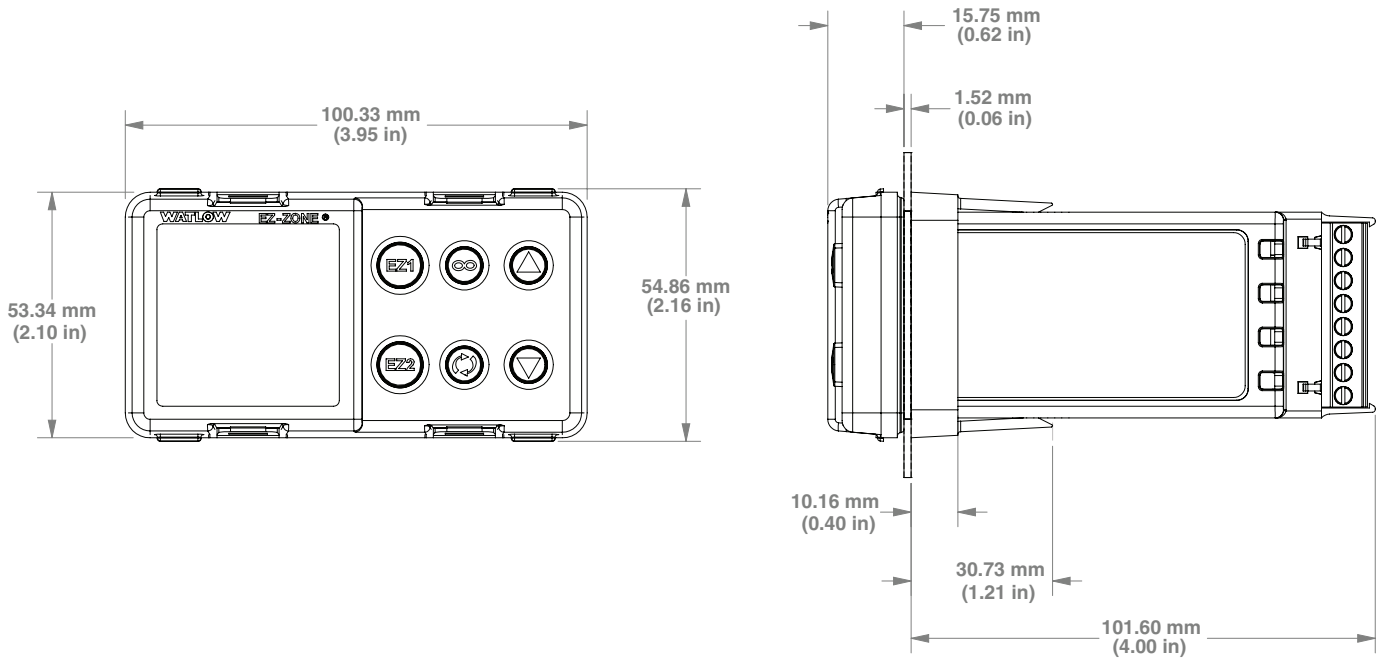

## 1/8 DIN (PM9) Horizontal Recommended Panel Spacing

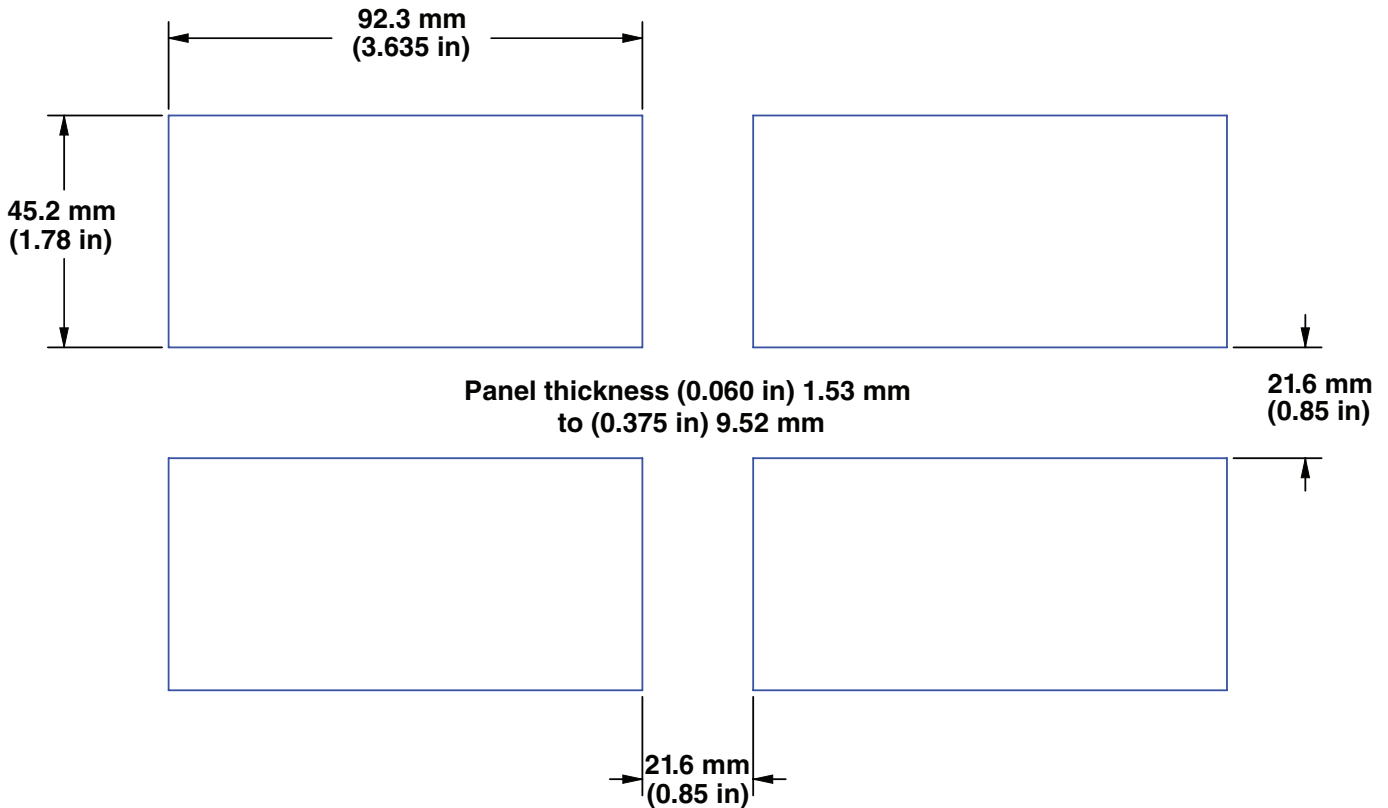

## 1/4 DIN (PM4) Dimensions

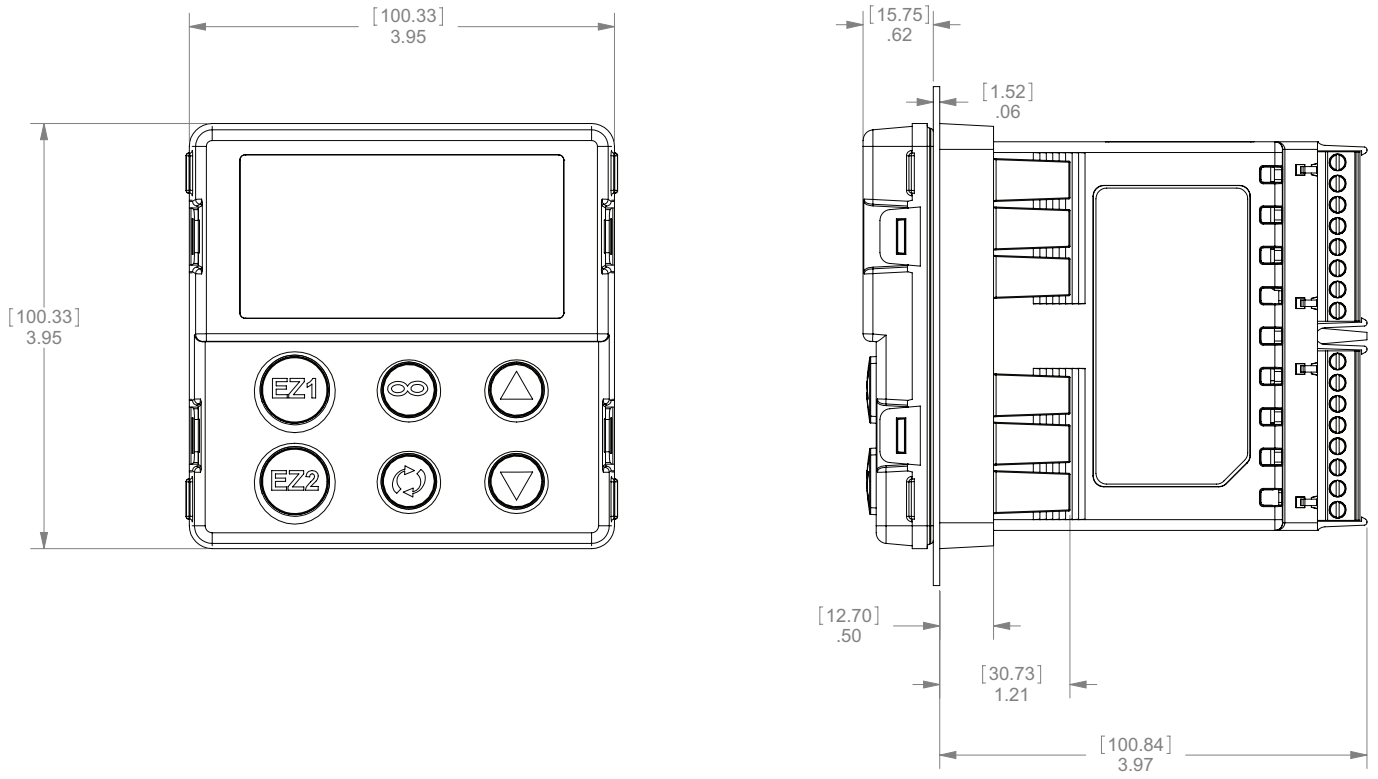

## 1/4 DIN (PM4) Recommended Panel Spacing

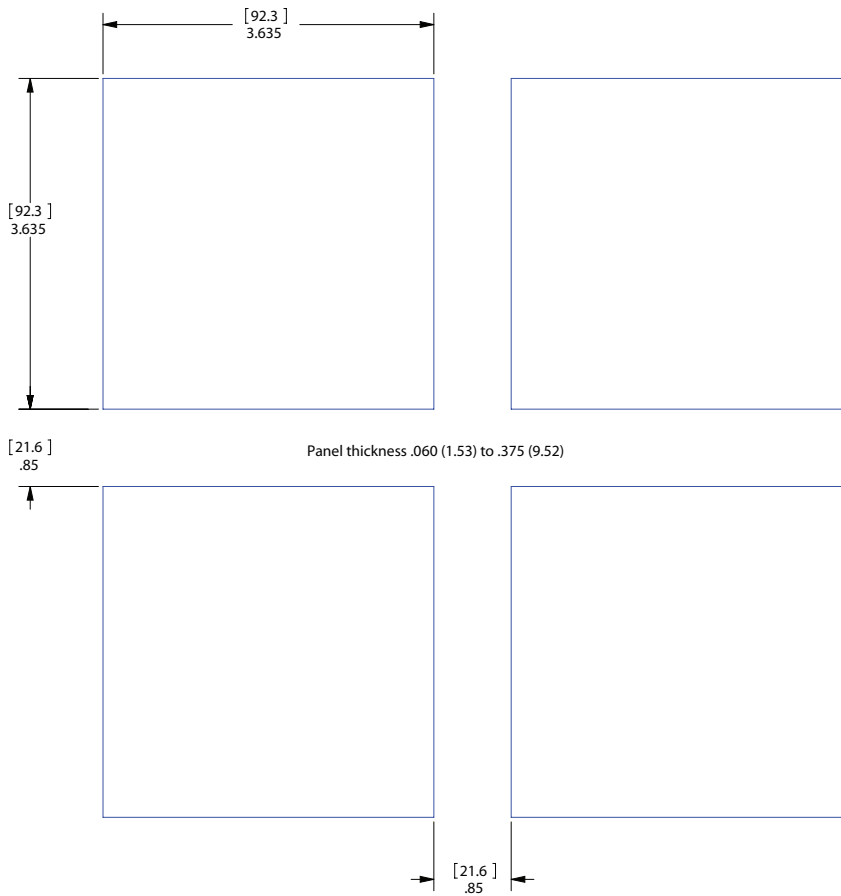

# Installation

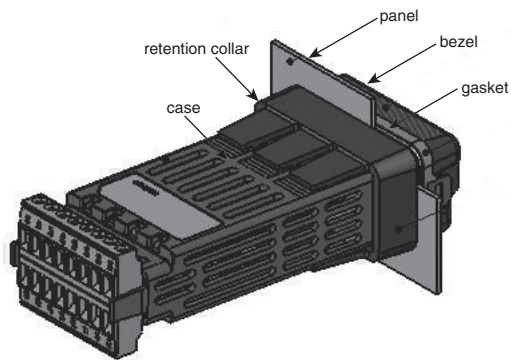
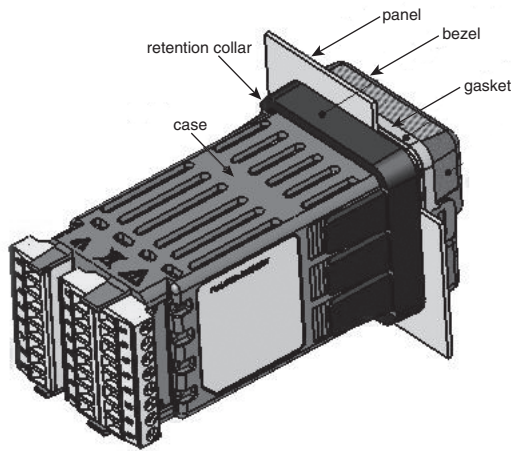

1. Make the panel cutout using the mounting template dimensions in this chapter.  
Insert the case assembly into the panel cutout.
2. While pressing the case assembly firmly against the panel, slide the mounting collar over the back of the controller.  
If the installation does not require a NEMA 4X seal, simply slide together until the gasket is compressed.

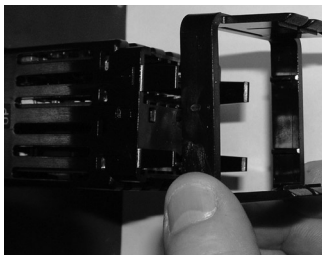

Slide the mounting collar over the back of the controller.

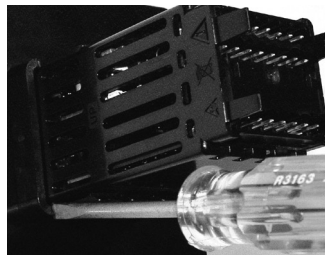

Place the blade of a screwdriver in the notch of the mounting collar assembly.

3. For a NEMA 4X (UL50, IP66) seal, alternately place and push the blade of a screwdriver against each of the the four corners of the mounting collar assembly. Apply pressure to the face of the controller while pushing with the screwdriver.

Don't be afraid to apply enough pressure to properly install the controller. The seal system is compressed more by mating the mounting collar tighter to the front panel (see pictures above). If you can move the case assembly back and forth in the cutout, you do not have a proper seal.

The tabs on each side of the mounting collar have teeth that latch into the ridges on the sides of the controller. Each tooth is staggered at a different depth from the front so that only one of the tabs, on each side, is locked onto the ridges at a time.

**Note:** There is a graduated measurement difference between the upper and lower half of the display to the panel. In order to meet the seal requirements mentioned above, ensure that the distance from the front of the top half of the display to the panel is 16 mm (0.630 in.) or less, and the distance from the front of the bottom half and the panel is 13.3 mm (0.525 in.) or less.

## Removing the Mounted Controller from Its Case

1. From the controller's face, pull out the tabs on each side until you hear it click.



Pull out the tab on each side until you hear it click.



Grab the unit above and below the face and pull forward.

2. On a PM6 control once the sides are released grab the unit above and below the face with two hands and pull the unit out. On the PM4/8/9 controls slide a screwdriver under the pry tabs and turn.



### Warning:

- This equipment is suitable for use in class 1, div. 2, Groups A, B, C and D or Non-Hazardous locations only. Temperature Code T4A.
- **WARNING – EXPLOSION HAZARD.** Substitution of component may impair suitability for class 1, div. 2.
- **WARNING – EXPLOSION HAZARD.** Do not disconnect equipment unless power has been switched off or the area is known to be nonhazardous.

## Returning the Controller to its Case

1. Ensure that the orientation of the controller is correct and slide it back into the housing.

**Note:** The controller is keyed so if it feels that it will not

**slide back in do not force it. Check the orientation again and reinsert after correcting.**

2. Using your thumbs push on either side of the controller until both latches click.

## **Chemical Compatibility**

This product is compatible with acids, weak alkalis, alcohols, gamma radiation and ultraviolet radiation.

This product is not compatible with strong alkalis, organic solvents, fuels, aromatic hydrocarbons, chlorinated hydrocarbons, esters and ketones.



### **Warning:**

**All electrical power to the controller and controlled circuits must be disconnected before removing the controller from the front panel or disconnecting other wiring.**

**Failure to follow these instructions may cause an electrical shock and/or sparks that could cause an explosion in class 1, div. 2 hazardous locations.**

### Terminal Definitions for Slots A

Slot A			
Output		Terminal Function	Configuration
1	2		
X1 W1 Y1		common (Any switched dc output can use this common.) dc- (open collector) dc+	Switched dc/open collector output 1: PM ___ C _- AAAA _ _
	W2 Y2	dc- dc+	Switched dc output 2: PM ___ C- AAAA _ _
F1 G1 H1		voltage or current - voltage + current +	Universal Process output 1: PM ___ F _- AAAA _ _
L1 K1 J1		normally open common normally closed	Mechanical Relay 5 A, Form C output 1: PM ___ E _- AAAA _ _
	L2 K2	normally open common	NO-ARC 15 A, Form A output 2: PM[4, 6, 8, 9] ___ H- AAAA _ _
	L2 K2	normally open common	Mechanical Relay 5 A, Form A output 2: PM ___ J- AAAA _ _
L1 K1	L2 K2	normally open common	Solid-state Relay 0.5 A, Form A output 1: PM ___ K _- AAAA _ _ output 2: PM ___ K- AAAA _ _
<b>Inputs</b>			
1			
T1 S1 R1		S2 (RTD) or current + S3 (RTD), thermocouple -, current -, volts - or potentiometer wiper, thermistor S1 (RTD), thermocouple + or volts +, thermistor	Universal / Thermistor Input input 1: all configurations
Slot A			

### Terminal Definitions for Slot C

Slot C	Terminal Function	Configuration
98 99	power input: ac or dc+ power input: ac or dc-	all
CC CA CB	Standard Bus or Modbus RTU EIA-485 common Standard Bus or Modbus RTU EIA-485 T-/R- Standard Bus or Modbus RTU EIA-485 T+/R+	Standard Bus or Modbus PM ___ -1 AAAA _ _
CF CD CE	Standard Bus EIA-485 common Standard Bus EIA-485 T-/R- Standard Bus EIA-485 T+/R+	PM ___ -A AAAA _ _
B5 D6 D5	digital input-output common digital input or output 6 digital input or output 5	PM __ 2 _- AAAA _ _ PM __ 4 _- AAAA _ _

**Back View  
Slot Orientation  
1/16 DIN PM6**

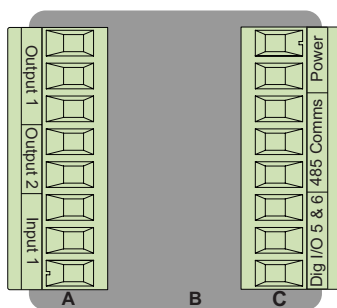

**Back View  
Slot Orientation  
1/32 DIN PM3**

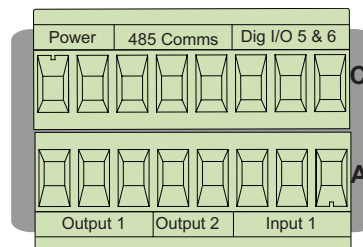



**Back View  
Slot Orientation 1/8  
DIN Vertical PM8**

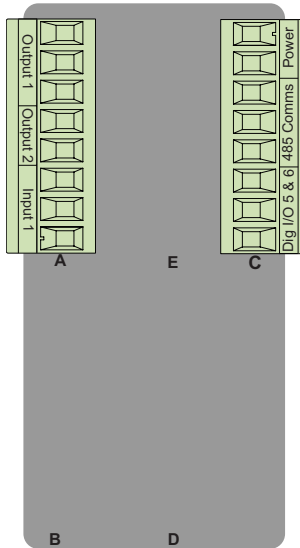

**Back View  
Slot Orientation  
1/8 DIN Horizontal PM9**

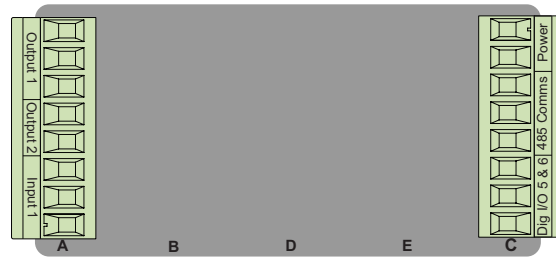

**Back View  
Slot Orientation  
1/4 DIN Horizontal PM4**

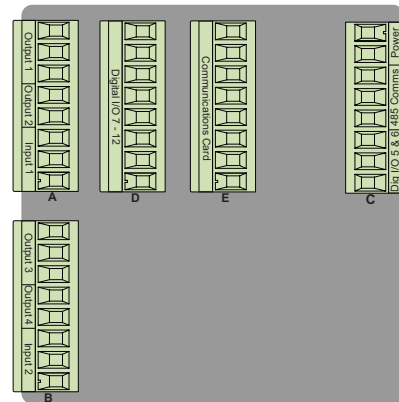

**EZ-ZONE PM Isolation Blocks**

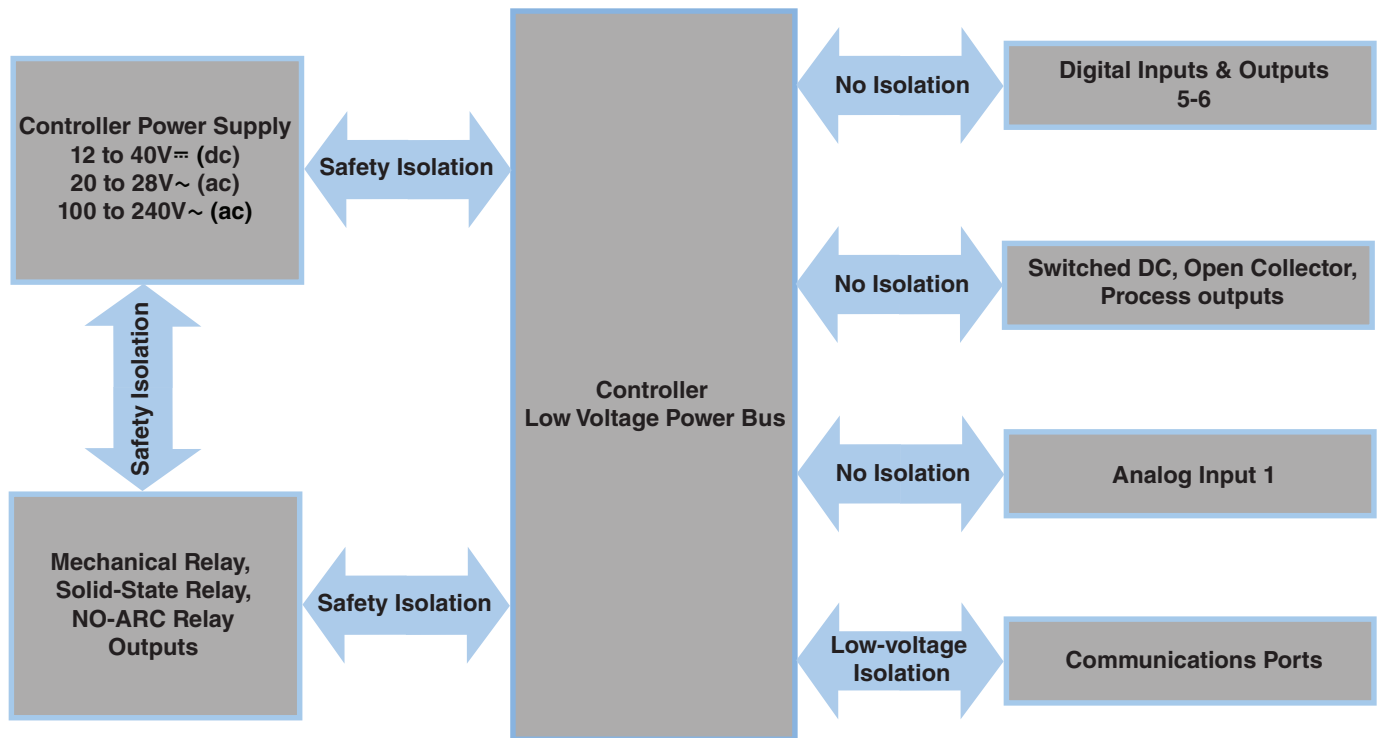

Low-voltage Isolation: 42V peak  
Safety Isolation: 2300V~ (ac)



**Warning:**  
Use National Electric (NEC) or other country-specific standard wiring and safety practices when wiring and connecting this controller to a power source and to electrical sensors or peripheral devices. Failure to do so may result in damage to equipment and property, and/or injury or loss of life.

**Note:**  
Maximum wire size termination and torque rating:  

- 0.0507 to 3.30 mm<sup>2</sup> (30 to 12 AWG) single-wire termination or two 1.31 mm<sup>2</sup> (16 AWG)
- 0.8 Nm (7.0 lb.-in.) torque

**Note:**  
Adjacent terminals may be labeled differently, depending on the model number.

**Note:**  
To prevent damage to the controller, do not connect wires to unused terminals.

**Note:**  
Maintain electrical isolation between analog input 1, digital input-outputs, switched dc/open collector outputs and process outputs to prevent ground loops.

**Note:**  
The control output common terminal and the digital common terminal are referenced to different voltages and must remain isolated.

## Low Power

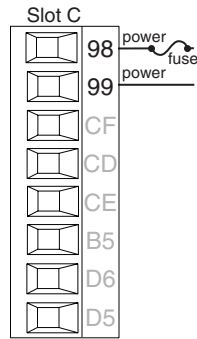

- Minimum/Maximum Ratings
  - 12 to 40V $\approx$  (dc)
  - 20 to 28V $\sim$  (ac) Semi Sig F47
  - 47 to 63 Hz
  - 14VA maximum power consumption (PM4,8 & 9)
  - 10VA maximum power consumption (PM3 & 6)
- PM\_\_ [3,4] \_ - - - - -

## High Power

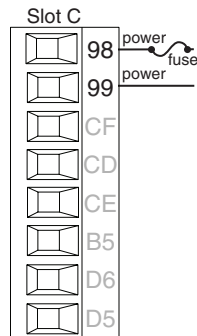

- Minimum/Maximum Ratings
  - 85 to 264V $\sim$  (ac)
  - 100 to 240V $\sim$  (ac) Semi Sig F47
  - 47 to 63 Hz
  - 14VA maximum power consumption (PM4,8 & 9)
  - 10VA maximum power consumption (PM3 & 6)
- PM\_\_ [1,2] \_ - - - - -

## Digital Input 5, 6

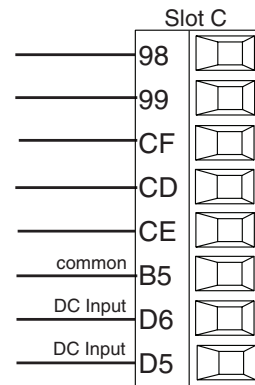

- Digital Input**
- Update rate 10 Hz
  - Dry contact or dc voltage

- DC Voltage**
- Input not to exceed 36V at 3 mA
  - Input active when > 3V @ 0.25 mA
  - Input inactive when < 2V

- Dry Contact**
- Input inactive when > 500  $\Omega$
  - Input active when < 100  $\Omega$
  - maximum short circuit 13 mA
- PM\_\_ [2,4] \_ - - - - -

### Voltage Input

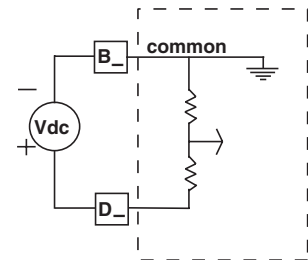

### Dry Contact

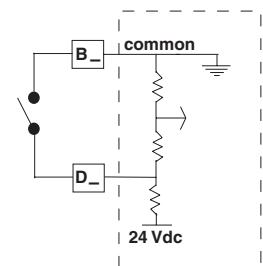



**Warning:**  
Use National Electric (NEC) or other country-specific standard wiring and safety practices when wiring and connecting this controller to a power source and to electrical sensors or peripheral devices. Failure to do so may result in damage to equipment and property, and/or injury or loss of life.

**Note:**  
Maximum wire size termination and torque rating:  
 • 0.0507 to 3.30 mm<sup>2</sup> (30 to 12 AWG) single-wire termination or two 1.31 mm<sup>2</sup> (16 AWG)  
 • 0.8 Nm (7.0 lb.-in.) torque

**Note:**  
Adjacent terminals may be labeled differently, depending on the model number.

**Note:**  
To prevent damage to the controller, do not connect wires to unused terminals.

**Note:**  
Maintain electrical isolation between analog input 1, digital input-outputs, switched dc/open collector outputs and process outputs to prevent ground loops.

**Note:**  
The control output common terminal and the digital common terminal are referenced to different voltages and must remain isolated.

## Input 1 Thermocouple

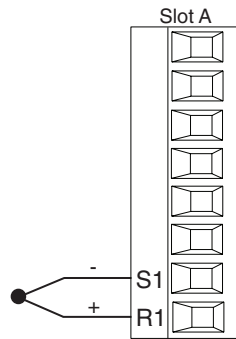

- 2 k $\Omega$  maximum source resistance
- >20 M $\Omega$  input impedance
- 3 microampere open-sensor detection
- Thermocouples are polarity sensitive. The negative lead (usually red) must be connected to S1.
- To reduce errors, the extension wire for thermocouples must be of the same alloy as the thermocouple.

PM \_ \_ \_ \_ \_ AAAA \_ \_

## Input 1 RTD

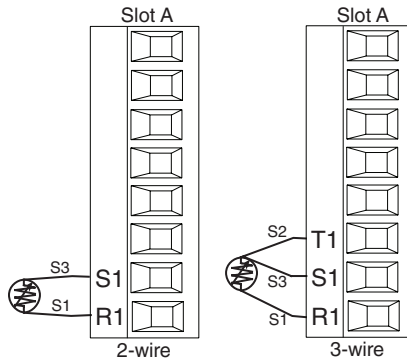

- platinum, 100 and 1,000  $\Omega$  @ 0°C
- calibration to DIN curve (0.00385  $\Omega/\Omega/^\circ\text{C}$ )
- 20  $\Omega$  total lead resistance
- RTD excitation current of 0.09 mA typical. Each ohm of lead resistance may affect the reading by 0.03°C.
- For 3-wire RTDs, the S1 lead (usually white) must be connected to R1.
- For best accuracy use a 3-wire RTD to compensate for lead-length resistance. All three lead wires must have the same resistance.

PM \_ \_ \_ \_ \_ AAAA \_ \_

## Input 1 Process

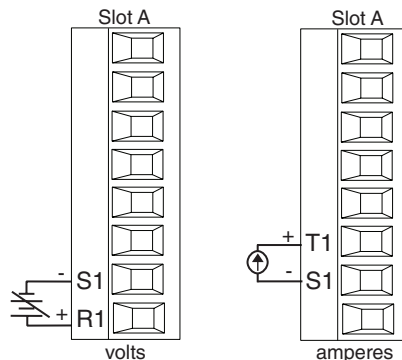

- 0 to 20 mA @ 100  $\Omega$  input impedance
- 0 to 10V $\overline{=}$  (dc) @ 20 k $\Omega$  input impedance
- 0 to 50 mV $\overline{=}$  (dc) @ 20 k $\Omega$  input impedance
- scalable

PM \_ \_ \_ \_ \_ AAAA \_ \_

## Input 1 Potentiometer

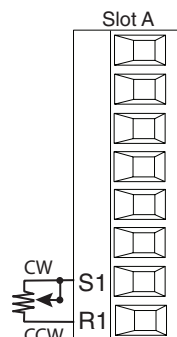

- Use a 1 k $\Omega$  potentiometer.

PM \_ \_ \_ \_ \_ AAAA \_ \_



**Warning:**  
Use National Electric (NEC) or other country-specific standard wiring and safety practices when wiring and connecting this controller to a power source and to electrical sensors or peripheral devices. Failure to do so may result in damage to equipment and property, and/or injury or loss of life.

**Note:**  
Maximum wire size termination and torque rating:  
• 0.0507 to 3.30 mm<sup>2</sup> (30 to 12 AWG) single-wire termination or two 1.31 mm<sup>2</sup> (16 AWG)  
• 0.8 Nm (7.0 lb.-in.) torque

**Note:**  
Adjacent terminals may be labeled differently, depending on the model number.

**Note:**  
To prevent damage to the controller, do not connect wires to unused terminals.

**Note:**  
Maintain electrical isolation between analog input 1, digital input-outputs, switched dc/open collector outputs and process outputs to prevent ground loops.

**Note:**  
The control output common terminal and the digital common terminal are referenced to different voltages and must remain isolated.

## Input 1 Thermistor

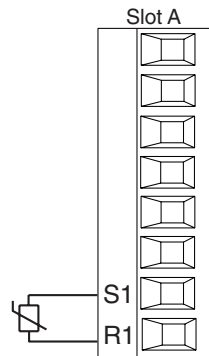

- >20 M $\Omega$  input impedance
  - 3 microampere open-sensor detection
- Input 1: PM \_ [J,N,E\*] \_ \_ \_ \_ \_ (S1/R1)

\*PM4,8 & 9 only



**Warning:**  
Use National Electric (NEC) or other country-specific standard wiring and safety practices when wiring and connecting this controller to a power source and to electrical sensors or peripheral devices. Failure to do so may result in damage to equipment and property, and/or injury or loss of life.

**Note:**  
Maximum wire size termination and torque rating:  
• 0.0507 to 3.30 mm<sup>2</sup> (30 to 12 AWG) single-wire termination or two 1.31 mm<sup>2</sup> (16 AWG)  
• 0.8 Nm (7.0 lb.-in.) torque

**Note:**  
Adjacent terminals may be labeled differently, depending on the model number.

**Note:**  
To prevent damage to the controller, do not connect wires to unused terminals.

**Note:**  
Maintain electrical isolation between analog input 1, digital input-outputs, switched dc/open collector outputs and process outputs to prevent ground loops.

**Note:**  
The control output common terminal and the digital common terminal are referenced to different voltages and must remain isolated.

**Quencharc Note:**  
Switching pilot duty inductive loads (relay coils, solenoids, etc.) with the mechanical relay, solid state relay or open collector output options requires use of an R.C. suppressor.

## Digital Output 5, 6

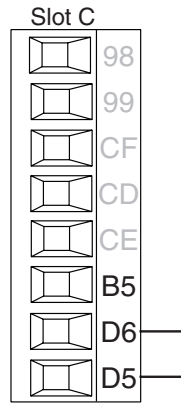

### Digital Output

- Update rate 10 Hz
  - Output voltage 24V
  - Current limit, Output 5, 24 mA maximum
  - Current limit, Output 6, 10 mA maximum driving single pole DIN-A-MITE
  - Capable of driving a 3-pole DIN-A-MITE
  - Open-circuit voltage 22 to 32V<sub>DC</sub> (dc)
- PM \_ \_ [2,4] \_ \_ \_ \_ \_

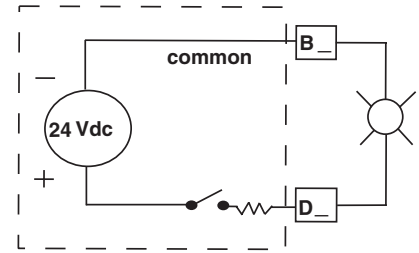

## Output 1 Switched DC/Open Collector

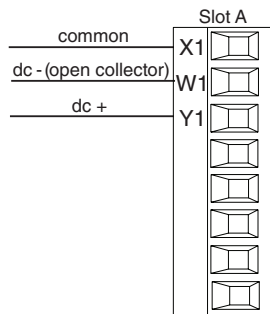

### Switched DC

- 30 mA dc maximum supply current
- short circuit limited to <50 mA
- 22 to 32V<sub>DC</sub> (dc) open circuit voltage
- Use dc- and dc+ to drive external solid-state relay.
- DIN-A-MITE compatible
- single-pole: up to 4 in parallel or 4 in series
- 2-pole: up to 2 in parallel or 2 in series
- 3-pole: up to 2 in series

### Open Collector

- 100 mA maximum output current sink
- 30V<sub>DC</sub> (dc) maximum supply voltage
- Any switched dc output can use the common terminal.
- Use an external power supply to control a dc load, with the load positive to the positive of the power supply, the load negative to the open collector and common to the power supply negative.

See Quencharc note.

PM \_ \_ \_ [C] \_ \_ AAAA \_ \_

### Switched DC

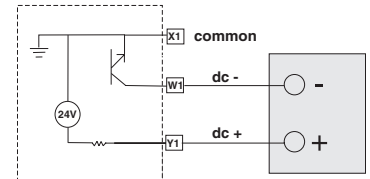

### Open Collector

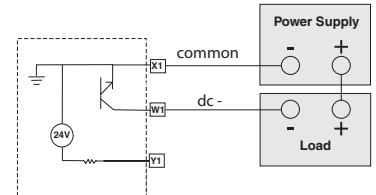

## Output 1 Mechanical Relay, Form C

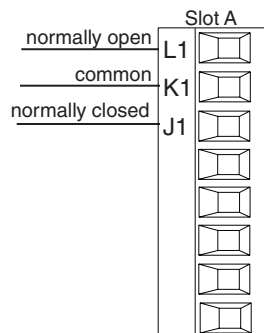

- 5 A at 240V<sub>AC</sub> (ac) or 30V<sub>DC</sub> (dc) maximum resistive load
- 20 mA at 24V minimum load
- 125 VA pilot duty at 120/240V<sub>AC</sub> (ac), 25 VA at 24V<sub>AC</sub> (ac)
- 100,000 cycles at rated load
- Output does not supply power.
- for use with ac or dc

See Quencharc note.

PM \_ \_ \_ [E] \_ \_ AAAA \_ \_

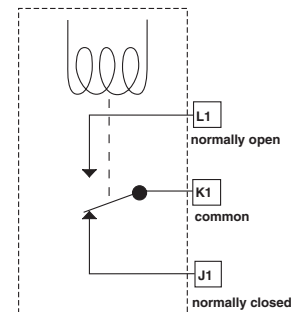



**Warning:**  
Use National Electric (NEC) or other country-specific standard wiring and safety practices when wiring and connecting this controller to a power source and to electrical sensors or peripheral devices. Failure to do so may result in damage to equipment and property, and/or injury or loss of life.

**Note:**  
Maximum wire size termination and torque rating:  
• 0.0507 to 3.30 mm<sup>2</sup> (30 to 12 AWG) single-wire termination or two 1.31 mm<sup>2</sup> (16 AWG)  
• 0.8 Nm (7.0 lb.-in.) torque

**Note:**  
Adjacent terminals may be labeled differently, depending on the model number.

**Note:**  
To prevent damage to the controller, do not connect wires to unused terminals.

**Note:**  
Maintain electrical isolation between analog input 1, digital input-outputs, switched dc/open collector outputs and process outputs to prevent ground loops.

**Note:**  
The control output common terminal and the digital common terminal are referenced to different voltages and must remain isolated.

**Quencharc Note:**  
Switching pilot duty inductive loads (relay coils, solenoids, etc.) with the mechanical relay, solid state relay or open collector output options requires use of an R.C. suppressor.

## Output 1 Universal Process

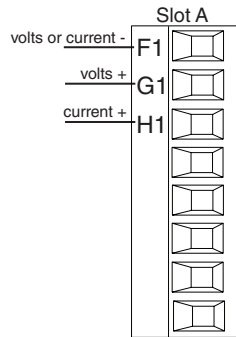

- 0 to 20 mA into 800 Ω maximum load
- 0 to 10V<sub>rms</sub> (dc) into voltage 1 kΩ minimum load
- scalable
- output supplies power
- cannot use voltage and current outputs at same time
- Output may be used as re-transmit or control.

PM \_ \_ \_ [F] \_ \_ AAAA \_ \_

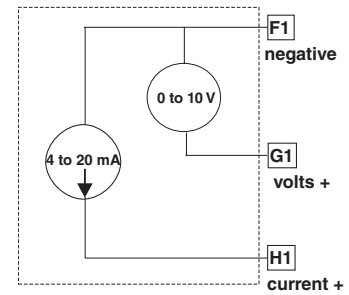

## Output 1 Solid-State Relay, Form A

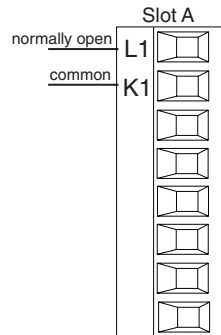

- 0.5 A at 20 to 264V<sub>rms</sub> (ac) maximum resistive load
- 20 VA 120/240V<sub>rms</sub> (ac) pilot duty
- opto-isolated, without contact suppression
- maximum off state leakage of 105 microamperes
- output does not supply power
- Do not use on dc loads.
- See Quencharc note.

PM \_ \_ \_ [K] \_ \_ AAAA \_ \_

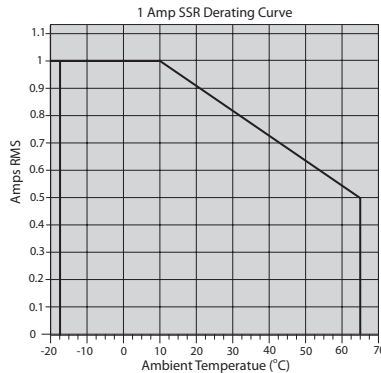
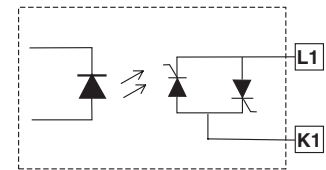

## Output 2 Switched DC

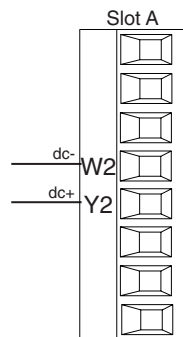

- 10 mA dc maximum supply current
- short circuit limited to <50 mA
- 22 to 32V<sub>rms</sub> (dc) open circuit voltage
- use dc- and dc+ to drive external solid-state relay
- DIN-A-MITE compatible
- single-pole: up to 2 in series, none in parallel

PM \_ \_ \_ [C] \_ \_ AAAA \_ \_

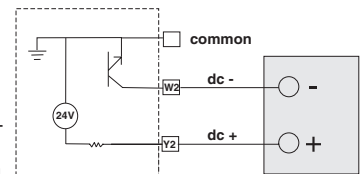



**Warning:**  
Use National Electric (NEC) or other country-specific standard wiring and safety practices when wiring and connecting this controller to a power source and to electrical sensors or peripheral devices. Failure to do so may result in damage to equipment and property, and/or injury or loss of life.

**Note:**  
Maximum wire size termination and torque rating:  
 • 0.0507 to 3.30 mm<sup>2</sup> (30 to 12 AWG) single-wire termination or two 1.31 mm<sup>2</sup> (16 AWG)  
 • 0.8 Nm (7.0 lb.-in.) torque

**Note:**  
Adjacent terminals may be labeled differently, depending on the model number.

**Note:**  
To prevent damage to the controller, do not connect wires to unused terminals.

**Note:**  
Maintain electrical isolation between analog input 1, digital input-outputs, switched dc/open collector outputs and process outputs to prevent ground loops.

**Note:**  
The control output common terminal and the digital common terminal are referenced to different voltages and must remain isolated.

**Quencharc Note:**  
Switching pilot duty inductive loads (relay coils, solenoids, etc.) with the mechanical relay, solid state relay or open collector output options requires use of an R.C. suppressor.

### Output 2 NO-ARC Relay, Form A

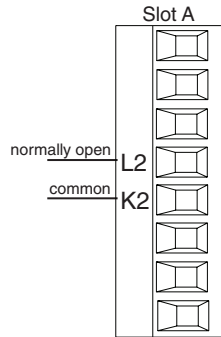

- 15 A at 85 to 264V~ (ac) resistive load only
  - 1/16 DIN models only
  - 2,000,000 cycle rating for NO-ARC circuit
  - 100 mA minimum load
  - 2 mA maximum off state leakage
  - Do not use on dc loads.
  - Output does not supply power.
- PM [4, 6, 8, 9] \_ \_ \_ [H]\_ AAAA  
 --

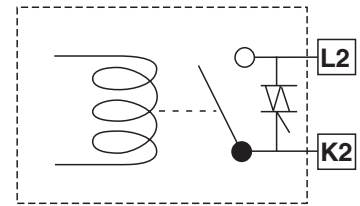

### Output 2 Mechanical Relay, Form A

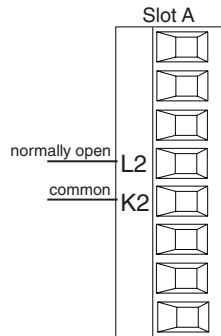

- 5 A at 240V~ (ac) or 30V= (dc) maximum resistive load
  - 20 mA at 24V minimum load
  - 125 VA pilot duty @ 120/240V~ (ac), 25 VA at 24V~ (ac)
  - 100,000 cycles at rated load
  - Output does not supply power.
  - for use with ac or dc
- See Quencharc note.  
 PM \_ \_ \_ \_ [J]\_ AAAA \_ \_

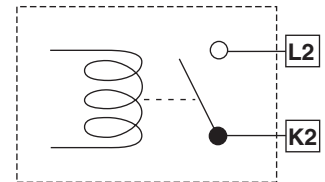

### Output 2 Solid-state Relay, Form A

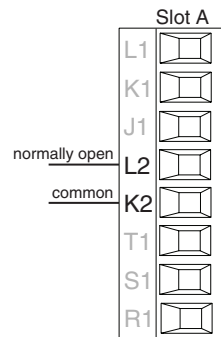

- 0.5 A at 20 to 264V~ (ac) maximum resistive load
  - 20 VA 120/240V~ (ac) pilot duty
  - opto-isolated, without contact suppression
  - maximum off state leakage of 105 microamperes
  - Output does not supply power.
  - Do not use on dc loads.
- See Quencharc note.  
 PM \_ \_ \_ \_ [K]\_ AAAA \_ \_

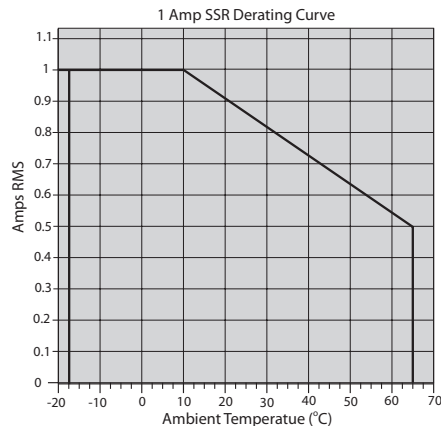
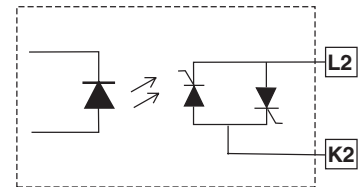





**Warning:**

**Use National Electric (NEC) or other country-specific standard wiring and safety practices when wiring and connecting this controller to a power source and to electrical sensors or peripheral devices. Failure to do so may result in damage to equipment and property, and/or injury or loss of life.**

**Note:**

**Maximum wire size termination and torque rating:**

- 0.0507 to 3.30 mm<sup>2</sup> (30 to 12 AWG) single-wire termination or two 1.31 mm<sup>2</sup> (16 AWG)
- 0.8 Nm (7.0 lb.-in.) torque

**Note:**

**Adjacent terminals may be labeled differently, depending on the model number.**

**Note:**

**To prevent damage to the controller, do not connect wires to unused terminals.**

**Note:**

**Maintain electrical isolation between analog input 1, digital input-outputs, switched dc/open collector outputs and process outputs to prevent ground loops.**

**Note:**

**The control output common terminal and the digital common terminal are referenced to different voltages and must remain isolated.**

## Quencharc Wiring Example

In this example the Quencharc circuit (Watlow part# 0804-0147-0000) is used to protect PM internal circuitry from the counter electromagnetic force from the inductive user load when de-energized. It is recommended that this or an equivalent Quencharc be used when connecting inductive loads to PM outputs.

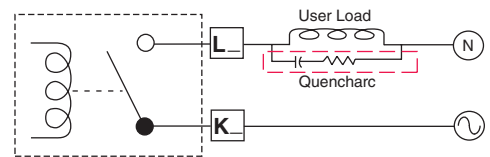



**Warning:**  
Use National Electric (NEC) or other country-specific standard wiring and safety practices when wiring and connecting this controller to a power source and to electrical sensors or peripheral devices. Failure to do so may result in damage to equipment and property, and/or injury or loss of life.

**Note:**  
Maximum wire size termination and torque rating:  
• 0.0507 to 3.30 mm<sup>2</sup> (30 to 12 AWG) single-wire termination or two 1.31 mm<sup>2</sup> (16 AWG)  
• 0.8 Nm (7.0 lb.-in.) torque

**Note:**  
Adjacent terminals may be labeled differently, depending on the model number.

**Note:**  
To prevent damage to the controller, do not connect wires to unused terminals.

**Note:**  
Maintain electrical isolation between analog input 1, digital input-outputs, switched dc/open collector outputs and process outputs to prevent ground loops.

**Note:**  
The control output common terminal and the digital common terminal are referenced to different voltages and must remain isolated.

**Note:**  
Avoid continuous writes within loops. Excessive writes to EEPROM will cause premature EEPROM failure. The EEPROM is rated for 1,000,000 writes.

## Standard Bus EIA-485 Communications

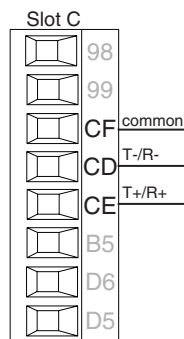

- Wire T-/R- to the A terminal of the EIA-485 port.
- Wire T+/R+ to the B terminal of the EIA-485 port.
- Wire common to the common terminal of the EIA-485 port.
- Do not route network wires with power wires. Connect network wires in daisy-chain fashion when connecting multiple devices in a network.
- Do not connect more than 16 EZ-ZONE PM controllers on a network.
- maximum network length: 1,200 meters (4,000 feet)
- 1/8th unit load on EIA-485 bus  
PM \_\_\_\_\_-[A] AAAA \_ \_

## Modbus RTU or Standard Bus EIA-485 Communications

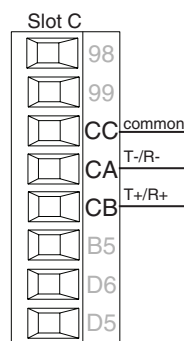

- Wire T-/R- to the A terminal of the EIA-485 port.
- Wire T+/R+ to the B terminal of the EIA-485 port.
- Wire common to the common terminal of the EIA-485 port.
- Do not route network wires with power wires. Connect network wires in daisy-chain fashion when connecting multiple devices in a network.
- A termination resistor may be required. Place a 120 Ω resistor across T+/R+ and T-/R- of last controller on network.
- Only one protocol per port is available at a time: either Modbus RTU or Standard Bus.
- Do not connect more than 16 EZ-ZONE PM controllers on a Standard Bus network.
- Do not connect more than 247 EZ-ZONE PM controllers on a Modbus RTU network.
- maximum network length: 1,200 meters (4,000 feet)
- 1/8th unit load on EIA-485 bus.  
PM \_\_\_\_\_-[1] AAAA \_ \_

Modbus-IDA Terminal	EIA/TIA-485 Name	Watlow Terminal Label	Function
DO	A	CA or CD	T-/R-
D1	B	CB or CE	T+/R+
common	common	CC or CF	common

## Wiring a Serial EIA-485 Network

Two example networks are shown below where the first one is using Watlow's Standard Bus and the other showing connections over Modbus. Do not route network wires with power wires. Connect network wires in daisy-chain fashion when connecting multiple devices in a network. A termination resistor may be required. Place a 120 Ω resistor across T+/R+ and T-/R- of the last controller on a network. Only one protocol per port is available at a time: either Modbus RTU or Standard Bus.



**Warning:**  
Use National Electric (NEC) or other country-specific standard wiring and safety practices when wiring and connecting this controller to a power source and to electrical sensors or peripheral devices. Failure to do so may result in damage to equipment and property, and/or injury or loss of life.

**Note:**  
Maximum wire size termination and torque rating:  
• 0.0507 to 3.30 mm<sup>2</sup> (30 to 12 AWG) single-wire termination or two 1.31 mm<sup>2</sup> (16 AWG)  
• 0.8 Nm (7.0 lb.-in.) torque

**Note:**  
Adjacent terminals may be labeled differently, depending on the model number.

**Note:**  
To prevent damage to the controller, do not connect wires to unused terminals.

**Note:**  
Maintain electrical isolation between analog input 1, digital input-outputs, switched dc/open collector outputs and process outputs to prevent ground loops.

**Note:**  
The control output common terminal and the digital common terminal are referenced to different voltages and must remain isolated.

### A Network Using Watlow's Standard Bus and an RUI/Gateway

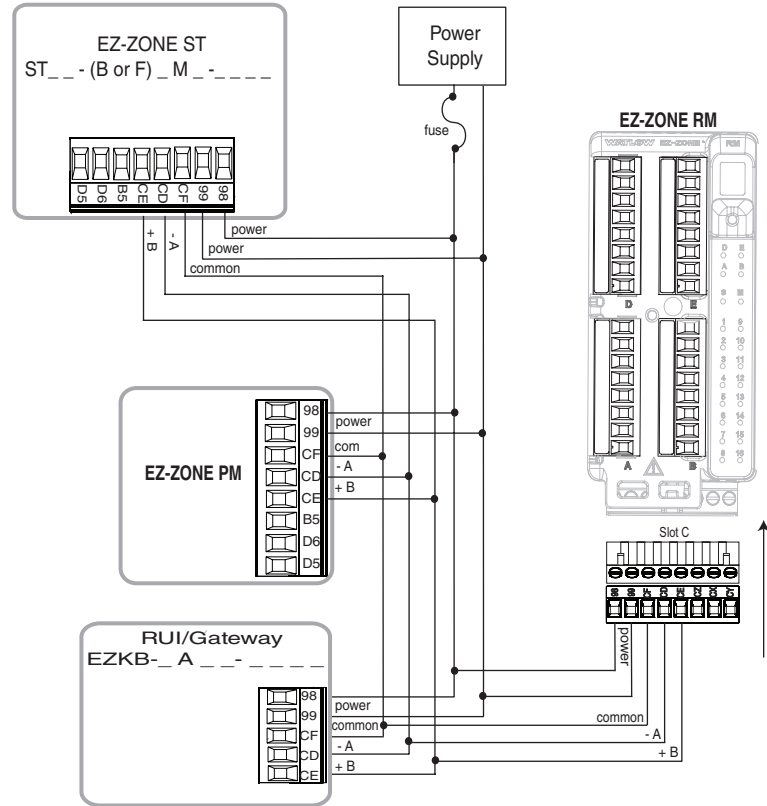

### A Network Using Modbus RTU.

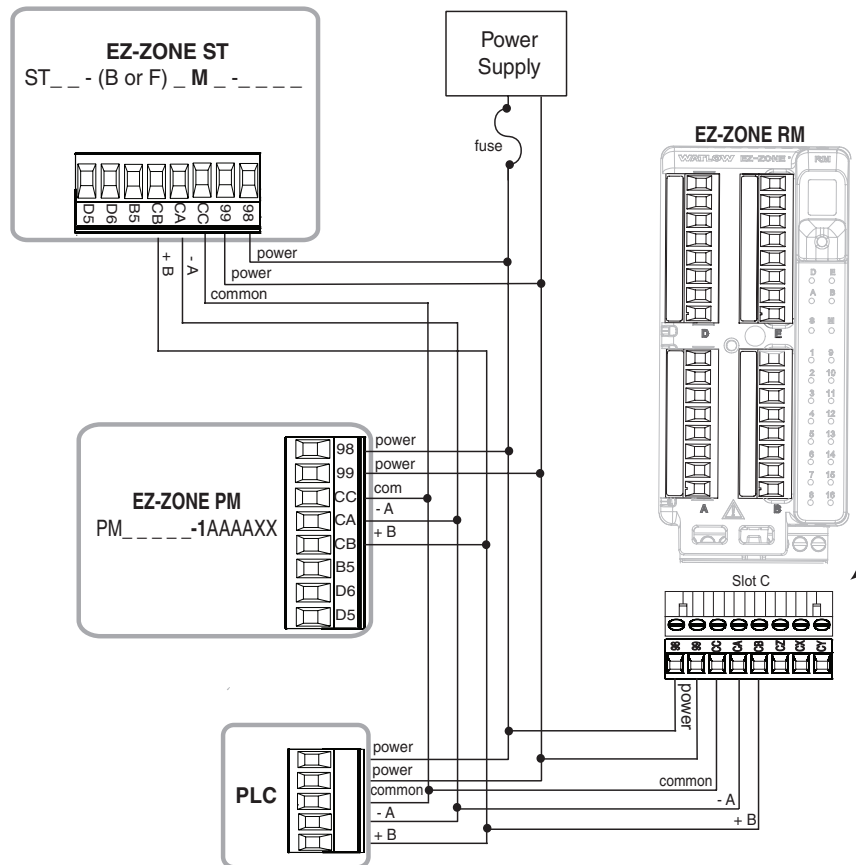

# 3

## Chapter 3: Keys and Displays

### Upper (Left, 32<sup>nd</sup> DIN) Display:

In the Home Page, displays the process value, otherwise displays the value of the parameter in the lower display.

### Zone Display:

Indicates the controller zone.

1 to 9 = zones 1 to 9

A = zone 10      E = zone 14

b = zone 11      F = zone 15

C = zone 12      h = zone 16

d = zone 13

### Percent Units:

Lights when the controller is displaying values as a percentage or when the open-loop set point is displayed.

### Channel Display:

Indicates the channel for any given EZ-ZONE module.

- Available with the PM4, 8 and PM9 only.

### Infinity Key ∞

Press to back up one level, or press and hold for two seconds to return to the Home Page. From the Home Page can clear alarms and errors if clearable.

### Advance Key ↻

Advances through parameter prompts.

### 1/32 DIN (PM3)

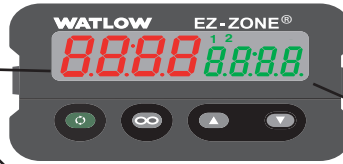

### 1/16 DIN (PM6)



### 1/8 DIN (PM9) Horizontal

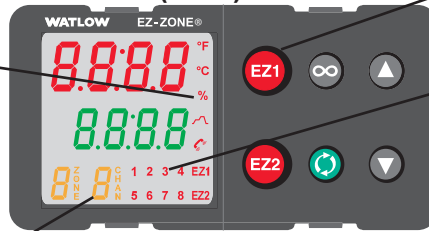

### 1/8 DIN (PM8) Vertical



### 1/4 DIN (PM4)

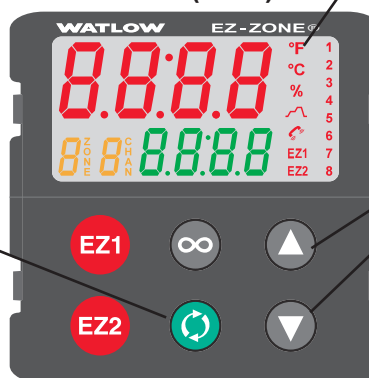

### Lower (Right, 32<sup>nd</sup> DIN) Display:

Indicates the set point or output power value during operation, or the parameter whose value appears in the upper display.

### Profile Activity:

Lights when a profile is running. Flashes when a profile is paused.

### EZ Key/s:

This key can be programmed to do various tasks, such as locking the keyboard, restoring user settings, etc...

### Output Activity:

Number LEDs indicate activity of outputs. A flashing light indicates output activity.

### Communications Activity

Flashes when another device is communicating with this controller.

### Temperature Units:

Indicates whether the temperature is displayed in Fahrenheit or Celsius.

### Up and Down Keys ▲ ▼

In the Home Page, adjusts the set point in the lower display. In other pages, changes the upper display to a higher or lower value, or changes a parameter selection.

## Responding to a Displayed Message

An active message will cause the display to toggle between the normal settings and the active message in the upper display and **ALLEN** in the lower display.

Your response will depend on the message and the controller settings. Some messages, such as Ramping and Tuning, indicate that a process is underway. If the message was generated by a latched alarm and the condition no longer exists or if an alarm has si-

lencing enabled it can be silenced simply by pushing the Infinity **∞** key. Alternatively, use the method below to view all and then clear.

Push the Advance Key to display **.900** in the upper display and the message source (such as **ALh1**) in the lower display. Use the Up **▲** or Down **▼** keys to scroll through possible responses, such as Clear **CLR** or Silence **SIL**. Then push the Advance **⊙** or Infinity **∞** key to execute the action. See the Home Page for further information on the Attention Codes.

Display	Parameter Name Description	Range	Appears If
<b>ALLEN</b>	<p><b>Attention</b></p> <p>An active message will cause the display to toggle between the normal settings and the active message in the upper display and <b>ALLEN</b> in the lower display.</p> <p>Your response will depend on the message and the controller settings. Some messages, such as Ramping and Tuning, indicate that a process is underway. If the message was generated by a latched alarm or limit condition, the message can be cleared when the condition no longer exists. If an alarm has silencing enabled, it can be silenced.</p> <p>Push the Advance Key to display <b>.900</b> in the upper display and the message source (such as <b>ALh1</b>) in the lower display.</p> <p>Use the Up <b>▲</b> or Down <b>▼</b> keys to scroll through possible responses, such as Clear <b>CLR</b> or Silence <b>SIL</b>. Then push the Advance <b>⊙</b> or Infinity <b>∞</b> key to execute the action. Alternatively, rather than scrolling through all messages simply push the Infinity <b>∞</b> button to generate a clear.</p>	<p><b>ALL1 ALL2 ALL3</b> <b>ALL4</b> Alarm Low 1 to 4</p> <p><b>ALh1 ALh2 ALh3</b> <b>ALh4</b> Alarm High 1 to 4</p> <p><b>ALE1 ALE2 ALE3</b> <b>ALE4</b> Alarm Error 1 to 4</p> <p><b>Er.1</b> Error Input 1</p> <p><b>EUn1</b> Tuning 1</p> <p><b>rP1</b> Ramping 1</p> <p><b>LPo1</b> Loop Open Error 1</p> <p><b>LPr1</b> Loop Reversed Error 1</p>	<p>an alarm or error message is active.</p>

# 4

## Chapter 4: Home Page

### Default Home Page Parameters

Watlow's patented user-defined menu system improves operational efficiency. The user-defined Home Page provides you with a shortcut to monitor or change the parameter values that you use most often. The default Home Page is shown on the following page. When a parameter normally located in the Setup Page or Operations Page is placed in the Home Page, it is accessible through both. If you change a parameter in the Home Page, it is automatically changed in its original page. If you change a parameter in its original page it is automatically changed in the Home Page.

The Attention **[RETR]** parameter appears only if there is an active message. An example of an active message could be an Input Error **[ERRI]**, or it could be for information only like Autotune **[EUN1]** taking place.

Use the Advance Key **[⏩]** to step through the other parameters. When not in pairs the parameter prompt will appear in the lower display, and the parameter value will appear in the upper display. You can use the Up **[↑]** and Down **[↓]** keys to change the value of writable parameters, just as you would in any other menu.

If Control Mode is set to Auto, the Process Value is in the upper display and the Closed Loop Set Point (read-write) is in the lower display.

If a profile is running, the process value is in the upper display and the Target Set Point (read only) is in the lower display. If Control Mode is set to Manual, the Process Value is in the upper display and the output power level (read-write) is in the lower display.

If Control Mode is set to Off, the Process Value is in the upper display and **[OFF]** (read only) is in the lower display.

If a sensor failure has occurred, **[----]** is in the upper display and the output power level (read-write) is in the lower display.

### Changing the Set Point

You can change the set point by using the Up **[↑]** or Down **[↓]** keys when a profile is not running.

### Modifying the Home Page

To modify the Home Page proceed to the Factory Menu by pushing and holding the Advance **[⏩]** key and the Infinity **[∞]** key for approximately six seconds. Upon entering the Factory Page the first menu will be the Custom Menu **[CUSE]**. Once there push the Advance **[⏩]** key where the lower display will show **[CUSE]** and the upper display will show **[?]**. Again, push the Advance **[⏩]** button where the prompt for the

Active Process Value **[RCPV]** will be displayed on top and Parameter **[PRR]** in the bottom. Using the Up **[↑]** or Down **[↓]** arrow keys will allow for a customized selection of choice. There are twenty positions available that can be customized.

### Modifying the Display Pairs

The Home Page, being a customized list of as many as 20 parameters can be configured in pairs of up to 10 via the Display Pairs **[dPS]** prompt found in the Diagnostic Menu **[dRG]** (Factory Page). The listing in the table that follows is what one may typically find in the Home Page as defaults based on controller part numbers. It is important to note that some of the prompts shown may not appear simply because the feature is not being used or is turned off. As an example, the prompt Cool Power **[CPL]** will not appear unless the Cool algorithm **[CRG]** is turned on in the Setup Page under the Loop menu. The Display Pairs **[dPS]** prompt will default to 1, therefore the upper display will reflect the Active Process Value **[RCPV]** and the lower display will reflect the Active Set Point **[RCLSP]** by default.

As stated above, the user can define pairs of prompts to appear on the display every time the Advance **[⏩]** key is pushed. When configuring the Custom Menu to your liking it should be noted that if 2 changeable (writable) prompts are displayed in a Pair, i.e., Control Mode on top and Idle Set Point on the bottom, only the lower display (Idle Set Point) can be changed.

The display can be configured to scroll by going to the Factory Page under the Diagnostic Menu and changing the Display Time **[dET]** prompt to something greater than 0. If set to 2, the display will scroll every 2 seconds from one Display Pair to another. If the Display Pair prompt **[dPS]** is set to 1 the Display Time **[dET]** prompt will have no effect on the display.

	Home Page Defaults	Home Page Display	Parameter Page and Menu
<b>All Models</b>			
1	Active Process Value (1)	Numerical value	Operations Page, Monitor Menu
2	Active Set Point (1)	Numerical value	Operations Page, Monitor Menu
3	User Control Mode (1)	<b>[C.P.M.]</b>	Operations Page, Monitor Menu
4	Heat Power (1)	<b>[h.P.r.]</b>	Operations Page, Monitor Menu
5	Cool Power (1)	<b>[C.P.r.]</b>	Operations Page, Monitor Menu
6	Autotune (1)	<b>[R.u.t.]</b>	Operations Page, Loop Menu
7	Idle (1)	<b>[.i.d.S.]</b>	Operations Page, Loop Menu
8	* Start Profile	<b>[P.S.t.]</b>	
9	* Action Request	<b>[P.R.C.]</b>	
10	None		
11	None		
12	None		
13	None		
14	None		
15	None		
16	None		
17	None		
18	None		
19	None		
20	None		

\* The fourth digit of the part number must be:  
 PM \_ **[R, B, N or E]** \_ \_ \_ - \_ \_ \_ \_ \_



# Navigating the EZ-ZONE® PM PID Controller

Applies to All Models - 1/16 DIN Shown Below

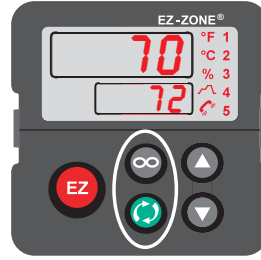

**Home Page from anywhere:** Press the Infinity Key ∞ for two seconds to return to the Home Page.

**Factory Page from Home Page:** Press both the Advance ↻ and Infinity ∞ keys for six seconds.

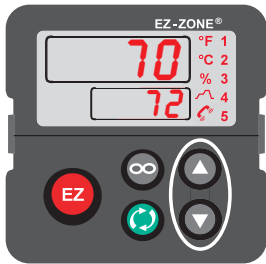

**Operations Page from Home Page:** Press both the Up ▲ and Down ▼ keys for three seconds.



**Setup Page from Home Page:** Press both the Up ▲ and Down ▼ keys for six seconds.

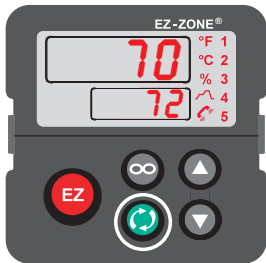

**Profiling Page from Home Page:** Press the Advance Key ↻ for three seconds.

## Conventions Used in the Menu Pages

To better understand the menu pages that follow review the naming conventions used. When encountered throughout this document, the word "default" implies as shipped from the factory. Each page (Operations, Setup, Profile and Factory) and their associated menus have identical headers defined below:

Header Name	Definition
Display	Visually displayed information from the control.
Parameter Name	Describes the function of the given parameter.
Range	Defines options available for this prompt, i.e., min/max values (numerical), yes/no, etc... (further explanation below).
Default	Values as delivered from the factory.
Parameter Appears in Menu When	Conditions required for parameter to appear in menu.
Modbus Relative Address	Identifies unique parameters using either the Modbus RTU or Modbus TCP protocols (further explanation below).
CIP (Common Industrial Protocol)	Identifies unique parameters using either the DeviceNet or EtherNet/IP protocol (further explanation below).
Data Type R/W	uint = Unsigned 16 bit integer dint = long, 32-bit string = ASCII (8 bits per character) float = IEEE 754 32-bit RWES = <b>R</b> eadable <b>W</b> ritable <b>E</b> EPROM (saved) <b>S</b> et (saved)

### Display

Visual information from the control is displayed to the observer using a fairly standard 7 segment display. Due to the use of this technology, several characters displayed need some interpretation, see the list below:

$\overline{1} = 1$	$\overline{0} = 0$	$\overline{i} = i$	$\overline{r} = r$
$\overline{2} = 2$	$\overline{A} = A$	$\overline{J} = J$	$\overline{S} = S$
$\overline{3} = 3$	$\overline{b} = b$	$\overline{H} = K$	$\overline{t} = t$
$\overline{4} = 4$	$\overline{c}, \overline{C} = c$	$\overline{L} = L$	$\overline{u} = u$
$\overline{5} = 5$	$\overline{d} = d$	$\overline{M} = M$	$\overline{v} = v$
$\overline{6} = 6$	$\overline{E} = E$	$\overline{n} = n$	$\overline{W} = W$
$\overline{7} = 7$	$\overline{F} = F$	$\overline{o} = o$	$\overline{y} = y$
$\overline{8} = 8$	$\overline{g} = g$	$\overline{P} = P$	$\overline{Z} = Z$
$\overline{9} = 9$	$\overline{h} = h$	$\overline{q} = q$	

### Range

Within this column notice that on occasion there will be numbers found within parenthesis. This number represents the enumerated value for that particular selection. Range selections can be made simply by writing the enumerated value of choice using any of the available communications protocols. As an example, turn to the Setup Page and look at the Analog Input  $\overline{A}$  menu and then the Sensor Type  $\overline{SEn}$  prompt. To turn the sensor off simply write the value of 62 (off) to Modbus register 400369 and send that value to the control.

### Modbus RTU Protocols

All Modbus registers are 16-bits and as displayed in this manual are relative addresses (actual). Some legacy software packages limit available Modbus registers to 40001 to 49999 (5 digits). Many applications today require access to all available Modbus registers which range from 400001 to 465535 (6 digits). Watlow controls support 6 digit Modbus registers. For parameters listed as float notice that only one (low order) of the two registers is listed, this is true throughout this document. By default the low order word contains the two low bytes of the 32-bit parameter. As an example, look in the Operations Page for the Process Value. Find the column identified in the header as Modbus and notice that it lists register 360. Because this parameter is a float it is actually represented by registers 360 (low order bytes) and 361 (high order bytes). Because the Modbus specification does not dictate which register should be high or low order Watlow provides the user the ability to swap this order (Setup Page,  $\overline{LoHi}$  Menu) from the default low/high  $\overline{LoHi}$  to high/low  $\overline{HiLo}$ .

### Note:

With the release of firmware revision 7.00 and above new functions where introduced into this product line. With the introduction of these new functions there was a reorganization of Modbus registers. Notice in the column identified as Modbus the reference to Map 1 and Map 2 registers for each of the various parameters. If the new functions, namely; Linearization, Process Value and Real Time Clock are to be used than use Map 2 Modbus registers. The Data Map  $\overline{P7AP}$  for Modbus registers can be changed in the Setup Page under the  $\overline{LoHi}$  Menu. This setting will apply across the control.

It should also be noted that some of the cells in the Modbus column contain wording pertaining to an offset. Several parameters in the control contain more than one instance; such as, profiles (4), alarms (4), analog inputs (2), etc... The Modbus register shown always represents instance one. Take for an example the Alarm Silence parameter found in the Setup Page under the Alarm menu. Instance one of Map 1 is shown as address 1490 and +50 is identified as the offset to the next instance. If there was a desire to read or write to instance 3 simply add 100 to 1490 to find its address, in this case, the instance 3 address for Alarm Silence is 1590.

To learn more about the Modbus protocol point your browser to <http://www.modbus.org>.

**Note:**

There are two columns shown in the menus that follow for communications protocols identified as CIP (Common Industrial Protocol) and Profibus. These columns will be useful if this control is used in conjunction with the EZ-ZONE Remote User Interface/Gateway where those protocols can be selected as optional hardware. For this control, as a secondary protocol beyond Standard Bus, Modbus RTU can be ordered as optional hardware.

To learn more about the RUI/GTW point your browser to the link below and search for keyword EZ-ZONE.

[http://www.watlow.com/literature/pti\\_search.cfm](http://www.watlow.com/literature/pti_search.cfm)

# 5

## Chapter 5: Operations Page

### Navigating the Operations Page

To go to the Operations Page from the Home Page, press both the Up ▲ and Down ▼ keys for three seconds. **A, I** will appear in the upper display and **oPEr** will appear in the lower display.

- Press the Up ▲ or Down ▼ key to view available menus. On the following pages top level menus are identified with a yellow background color.
- Press the Advance Key ⏭ to enter and view available prompts within a menu.

- Press the Up ▲ or Down ▼ key to move through available menu prompts.
- Press the Infinity Key ∞ to move backwards through the levels: parameter to submenu; submenu to menu; menu to Home Page.
- Press and hold the Infinity Key ∞ for two seconds to return to the Home Page.

#### Note:

Some of these menus and parameters may not appear, depending on the controller's options. See model number information in the Appendix for more information. If there is only one instance of a menu, no submenus will appear.

### Operations Page

**A, I**  
**oPEr** Analog Input Menu  
 I  
**A, I** Analog Input  
**A, In** Process Value  
**Er** Error Status  
**CA** Calibration Offset

**Lnr**\*  
**oPEr** Linearization Menu  
 I  
**Lnr** Linearization  
**SuR** Source Value A  
**oFSE** Offset  
**ou** Output Value

**Pu**\*  
**oPEr** Process Value Menu  
 I  
**Pu** Process Value  
**SuR** Source Value A  
**oFSE** Offset  
**ou** Output Value

**d, o**  
**oPEr** Digital Input/Output Menu  
 S to 5  
**d, o** Digital Input/Output  
**d, o, S** Output State  
**E, S** Event State  
**d, i, S** Input State

**Mon**  
**oPEr** Monitor Menu  
 I  
**Mon** Monitor  
**C, P, A** Control Mode Active  
**h, P, r** Heat Power  
**C, P, r** Cool Power  
**C, S, P** Closed Loop Working Set Point  
**P, u, R** Process Value Active

**Loop**  
**oPEr** Loop Menu  
 I  
**Loop** Loop  
**r, En** Remote Enable  
**C, P, A** Control Mode  
**A, E, S, P** Autotune Set Point  
**A, U, E** Autotune Request  
**C, S, P** Closed Loop Set Point  
**i, d, S** Idle Set Point  
**h, P, b** Heat Proportional Band  
**h, h, y** Heat Hysteresis  
**C, P, b** Cool Proportional Band  
**C, h, y** Cool Hysteresis  
**t, i** Time Integral  
**t, d** Time Derivative  
**d, b** Dead Band  
**o, S, P** Open Loop Set Point

**ALM**  
**oPEr** Alarm Menu  
 I to 4  
**ALM** Alarm 1  
**A, L, o** Low Set Point  
**A, h, i** High Set Point

**P, S, E, R**  
**oPEr** Profile Status Menu  
 I to 4  
**P, S, E, R** Profile Status  
**P, S, E, r** Profile Start  
**P, A, C, r** Action Request  
**S, E, P** Active Step  
**S, E, Y, P** Active Step Type  
**t, S, P, i** Target Set Point Loop 1  
**A, C, S, P** Produced Set Point 1  
**S, E, r** Step Type Remaining  
**E, n, E, 1** Active Event Output 1  
**E, n, E, 2** Active Event Output 2  
**J, C** Jump Count Remaining

\* Available with PM4, PM8 and PM9 models only

Operations Page

Display	Parameter name Description	Range	Default	Parameter Appears in Menu When	Modbus Rela- tive Address	CIP Class Instance Attribute hex (dec)	Profibus Index	Data Type & Read/ Write
<div style="border: 1px solid black; padding: 2px;"> <span style="border: 1px solid black; padding: 1px;">A</span> ,  <span style="border: 1px solid black; padding: 1px;">oPEr</span>  <b>Analog Input Menu</b> </div>								
<div style="border: 1px solid black; padding: 2px;"> <span style="border: 1px solid black; padding: 1px;">A</span> in                      [ Ain]                 </div>	<b>Analog Input (1) Process Value</b> View the process value.	-1,999.000 to 9,999.000°F or units -1,128.000 to 5,537.000°C	----	Always	<b>Instance 1</b> Map 1    Map 2 360      360 <b>Instance 2</b> Map 1    Map 2 440      450	0x68 (104) 1 1	0	float R
<div style="border: 1px solid black; padding: 2px;"> <span style="border: 1px solid black; padding: 1px;">iEr</span>                      [ i.Er]                 </div>	<b>Analog Input (1) Error Status</b> View the cause of the most recent error. If the <span style="border: 1px solid black; padding: 1px;">REtEn</span> message is <span style="border: 1px solid black; padding: 1px;">Er.i1</span> or <span style="border: 1px solid black; padding: 1px;">Er.i2</span> , this parameter will display the cause of the input error.	<span style="border: 1px solid black; padding: 1px;">nonE</span> None (61) <span style="border: 1px solid black; padding: 1px;">OPEn</span> Open (65) <span style="border: 1px solid black; padding: 1px;">FRiL</span> Fail (32) <span style="border: 1px solid black; padding: 1px;">ShrtE</span> Shorted (127) <span style="border: 1px solid black; padding: 1px;">EPn</span> Measurement Error (140) <span style="border: 1px solid black; padding: 1px;">ECAL</span> Bad Calibration Data (139) <span style="border: 1px solid black; padding: 1px;">ErAb</span> Ambient Error (9) <span style="border: 1px solid black; padding: 1px;">ErEd</span> RTD Error (141) <span style="border: 1px solid black; padding: 1px;">NSrc</span> Not Sourced (246)	None	Always	<b>Instance 1</b> Map 1    Map 2 362      362 <b>Instance 2</b> Map 1    Map 2 442      452	0x68 (104) 1 2	1	uint R
<div style="border: 1px solid black; padding: 2px;"> <span style="border: 1px solid black; padding: 1px;">iCR</span>                      [ i.CA]                 </div>	<b>Analog Input (1) Calibration Offset</b> Offset the input reading to compensate for lead wire resistance or other factors that cause the input reading to vary from the actual process value.	-1,999.000 to 9,999.000°F or units -1,110.555 to 5,555.000°C	0.0	Always	<b>Instance 1</b> Map 1    Map 2 382      382 <b>Instance 2</b> Map 1    Map 2 462      472	0x68 (104) 1 0xC (12)	2	float RWES
<div style="border: 1px solid black; padding: 2px;"> <span style="border: 1px solid black; padding: 1px;">Lnr</span> *  <span style="border: 1px solid black; padding: 1px;">oPEr</span>  <b>Linearization Menu</b> </div>								
<div style="border: 1px solid black; padding: 2px;"> <span style="border: 1px solid black; padding: 1px;">SuA</span>                      [ Su.A]                 </div>	<b>Linearization (1) Source Value A</b> View the value of Source A. Source A of Linearization 1 is connected to Analog Input 1	-1,999.000 to 9,999.000°F or units -1,128.000 to 5,537.000°C	----	Always if part number digit 3 is C, R, J, B, E or N.  PM8 and 9 only	<b>Instance 1</b> Map 1    Map 2 ----    3566	0x86 (134) 1 4	----	float R
<div style="border: 1px solid black; padding: 2px;"> <span style="border: 1px solid black; padding: 1px;">oFSt</span>                      [oFSt]                 </div>	<b>Linearization (1) Offset</b> Set an offset to be applied to this function's output.	-1,999.000 to 9,999.000°F or units -1,128.000 to 5,537.000°C	0	Always	<b>Instance 1</b> Map 1    Map 2 ----    3570	0x86 (134) 1 6	----	float RWES
<div style="border: 1px solid black; padding: 2px;"> <span style="border: 1px solid black; padding: 1px;">oV</span>                      [ o.v]                 </div>	<b>Linearization (1) Output Value</b> View the value of this function's output.	-1,999.000 to 9,999.000°F or units -1,128.000 to 5,537.000°C	----	Always	<b>Instance 1</b> Map 1    Map 2 ----    3572	0x86 (134) 1 7	----	float R
<b>Note:</b> Some values will be rounded off to fit in the four-character display. Full values can be read with other inter- faces.								R: Read W: Write E: EEPROM S: User Set
* Available with PM4, PM8 and PM9 models only								

Operations Page

Display	Parameter name Description	Range	Default	Parameter Appears in Menu When	Modbus Rela- tive Address	CIP Class Instance Attribute hex (dec)	Profibus Index	Data Type & Read/ Write
No Dis- play	<i>Linearization (1)</i> <b>Output Error</b> View reported cause for Linearization out- put malfunction.	None (61) Open (65) Shorted (127) Measurement error (140) Bad calibration data (139) Ambient error (9) RTD error (14) Fail (32) Math error (1423) Not sourced (246) Stale (1617) Can't process (1659)	----	----	<b>Instance 1</b> <i>Map 1</i> <i>Map 2</i> ----    3614	0x86 (134) 1 0x1C (28)	----	uint R
<div style="border: 1px solid black; background-color: #ffffcc; padding: 5px;"> <input type="checkbox"/> <b>PU</b>*  <input type="checkbox"/> <b>PER</b>  <b>Process Value Menu</b> </div>								
<input type="checkbox"/> <b>SuA</b> [ Sv.A]	<i>Process Value (1)</i> <b>Source Value A</b> View the value of Source A. Linearization 1 is con- nected to Source A of Process Value 1	-1,999.000 to 9,999.000°F or units -1,128.000 to 5,537.000°C	----	Always if part number digit 3 is C, R, J, B, E or N.  PM8 and 9 only	<b>Instance 1</b> <i>Map 1</i> <i>Map 2</i> ----    3310	0x7E (126) 1 0x10 (16)	----	float R
<input type="checkbox"/> <b>oFSE</b> [oFSt]	<i>Process Value (1)</i> <b>Offset</b> Set an offset to be ap- plied to this function's output.	-1,999.000 to 9,999.000°F or units -1,128.000 to 5,537.000°C	0	Always	<b>Instance 1</b> <i>Map 1</i> <i>Map 2</i> ----    3324	0x7E (126) 1 0x17 (23)	----	float RWES
<input type="checkbox"/> <b>o.v</b> [ o.v]	<i>Process Value (1)</i> <b>Output Value</b> View the value of this function block's output.	-1,999.000 to 9,999.000°F or units -1,128.000 to 5,537.000°C	----	Always	<b>Instance 1</b> <i>Map 1</i> <i>Map 2</i> ----    3322	0x7E (126) 1 0x16 (22)	----	float R
No Dis- play	<i>Process Value (1)</i> <b>Output Error</b> View reported cause for Process output malfunction.	None (61) Open (65) Shorted (127) Measurement error (140) Bad calibration data (139) Ambient error (9) RTD error (14) Fail (32) Math error (1423) Not sourced (246) Stale (1617) Can't process (1659)	----	----	<b>Instance 1</b> <i>Map 1</i> <i>Map 2</i> ----    3332	0x86 (134) 1 to 2 0x1B (27)	----	uint R
<b>Note:</b> Some values will be rounded off to fit in the four-character display. Full values can be read with other inter- faces.								R: Read W: Write E: EEPROM S: User Set
* Available with PM4, PM8 and PM9 models only								

Operations Page

Display	Parameter name Description	Range	Default	Parameter Appears in Menu When	Modbus Rela- tive Address	CIP Class Instance Attribute hex (dec)	Profibus Index	Data Type & Read/ Write
<b>d.o</b> <b>OPER</b> <b>Digital Input/Output Menu</b>								
<b>d.o.S</b> [ do.S]	<b>Digital Output (5 to 6) Output State</b> View the state of this output.	<b>OFF</b> Off (62) <b>ON</b> On (63)	----	Direction (Setup Page, Digital Input/Output Menu) is set to Output.	<b>Instance 1</b> Map 1    Map 2 1012    1132 Offset to next instance equals +30	0x6A (106) 1 to 2 7	90	uint R
<b>E.i.S</b> [ Ei.S]	<b>Digital Input (5 to 6) Event Status</b> View this event input state.	<b>OFF</b> Off (62) <b>ON</b> On (63)	----	Direction (Setup Page, Digital Input/Output Menu) is set to Input Voltage or Input Dry Contact.	<b>Instance 1</b> Map 1    Map 2 1328    1568 Offset to next instance equals +20	0x6E (110) 1 to 2 5	140	uint R
No Display	<b>EZ-Key/s (1 to 2) Event Status</b> View this event input state.	<b>OFF</b> Off (62) <b>ON</b> On (63)	----	----	<b>Instance 1</b> Map 1    Map 2 1368    1608  <b>Instance 2</b> Map 1    Map 2 ----    1628	0x6E (110) 3 to 4 5	140	uint R
<b>L.LL</b> <b>OPER</b> <b>Limit Menu</b>								
<b>LL.S</b> [ LL.S]	<b>Limit (1) Low Set Point</b> Set the low process value that will trigger the limit.	-1,999.000 to 9,999.000°F or units -1,128.000 to 5,537.000°C	0.0°F or units -18.0°C	Limit Sides (Setup Page) is not set to High.	<b>Instance 1</b> Map 1    Map 2 684        724	0x70 (112) 1 3	38	float RWES
<b>Lh.S</b> [ Lh.S]	<b>Limit (1) High Set Point</b> Set the high process value that will trigger the limit.	-1,999.000 to 9,999.000°F or units -1,128.000 to 5,537.000°C	0.0°F or units -18.0°C	Limit Sides (Setup Page) is not set to Low.	<b>Instance 1</b> Map 1    Map 2 686        726	0x70 (112) 1 4	39	float RWES
<b>PPON</b> <b>OPER</b> <b>Monitor Menu</b>								
<b>CPA</b> [ C.MA]	<b>Monitor (1) Control Mode Active</b> View the current control mode.	<b>OFF</b> Off (62) <b>AUTO</b> Auto (10) <b>MAN</b> Manual (54)	Off	Always	<b>Instance 1</b> Map 1    Map 2 1882    2362	0x97 (151) 1 2	----	uint R
<b>h.Pr</b> [ h.Pr]	<b>Monitor (1) Heat Power</b> View the current heat output level.	0.0 to 100.0%	0.0	Heat algorithm is not set to Off. (Setup Page)	<b>Instance 1</b> Map 1    Map 2 1904    2384	0x97 (151) 1 0xD (13)	----	float R
<b>CPr</b> [ C.Pr]	<b>Monitor (1) Cool Power</b> View the current cool output level.	-100.0 to 0.0%	0.0	Cool algorithm is not set to Off. (Setup Page)	<b>Instance 1</b> Map 1    Map 2 1906    2386	0x97 (151) 1 0xE (14)	----	float R
<b>Note:</b> Some values will be rounded off to fit in the four-character display. Full values can be read with other interfaces.  * Available with PM4, PM8 and PM9 models only								<b>R:</b> Read <b>W:</b> Write <b>E:</b> EEPROM <b>S:</b> User Set



Operations Page

Display	Parameter name Description	Range	Default	Parameter Appears in Menu When	Modbus Rela- tive Address	CIP Class Instance Attribute hex (dec)	Profibus Index	Data Type & Read/ Write
<b>[C.SP]</b> [ C.SP]	<i>Monitor (1)</i> <b>Closed Loop Working Set Point</b> View the set point currently in effect.	-1,999.000 to 9,999.000°F or units -1,128.000 to 5,537.000°C	----	Always	<b>Instance 1</b> <i>Map 1</i> <i>Map 2</i> 2172    2652	0x6B (107) 1 7	----	float R
<b>[Pv.A]</b> [ Pv.A]	<i>Monitor (1)</i> <b>Process Value Active</b> View the current filtered process value using the control input.	-1,999.000 to 9,999.000°F or units -1,128.000 to 5,537.000°C	----	Always	<b>Instance 1</b> <i>Map 1</i> <i>Map 2</i> 402    402	0x68 (104) 1 0x16 (22)	----	float R
<b>Loop</b> <b>OPER</b> <b>Loop Menu</b>								
<b>[r.En]</b> [ r.En]	<i>Loop (1)</i> <b>Remote Enable</b> Enable this loop to switch control to the remote set point.	<b>[no]</b> No <b>[YES]</b> Yes	No	Always	<b>Instance 1</b> <i>Map 1</i> <i>Map 2</i> 2200    2680	0x6B (107) 1 0x15 (21)	48	uint RWES
<b>[r.ty]</b> [ r.ty]	<i>Loop (1)</i> <b>Remote Set Point Type</b> Enable this loop to switch control to the remote set point.	<b>[Auto]</b> Auto (10) <b>[MAN]</b> Manual (54)	No	Remote enable set to yes	<b>Instance 1</b> <i>Map 1</i> <i>Map 2</i> 2202    2682	0x6B (107) 1 0x16 (22)	----	uint RWES
<b>[C.M]</b> [ C.M]	<i>Loop (1)</i> <b>Control Mode</b> Select the method that this loop will use to control.	<b>[off]</b> Off (62) <b>[Auto]</b> Auto (10) <b>[MAN]</b> Manual (54)	Auto	Always	<b>Instance 1</b> <i>Map 1</i> <i>Map 2</i> 1880    2360	0x97 (151) 1 1	63	uint RWES
<b>[A.tSP]</b> [ A.tSP]	<i>Loop (1)</i> <b>Autotune Set Point</b> Set the set point that the autotune will use, as a percentage of the current set point.	50.0 to 200.0%	90.0	Heat Algorithm or Cool Algorithm (Setup Page) is set to PID.	<b>Instance 1</b> <i>Map 1</i> <i>Map 2</i> 1998    2398	0x97 (151) 1 0x14 (20)	----	float RWES
<b>[AUT]</b> [ AUT]	<i>Loop (1)</i> <b>Autotune Request</b> Start an autotune. While the autotune is active, the Home Page will display <b>[Auto]</b> . When the autotune is complete, the message will clear automatically.	<b>[no]</b> No (59) <b>[YES]</b> Yes (106)	No	Heat Algorithm or Cool Algorithm (Setup Page) is set to PID.	<b>Instance 1</b> <i>Map 1</i> <i>Map 2</i> 1920    2400	0x97 (151) 1 0x15 (21)	64	uint RW
<b>[C.SP]</b> [ C.SP]	<i>Loop (1)</i> <b>Closed Loop Set Point</b> Set the set point that the controller will automatically control to.	Low Set Point to High Set Point (Setup Page)	75.0°F or units 24.0°C	Always	<b>Instance 1</b> <i>Map 1</i> <i>Map 2</i> 2160    2640	0x6B (107) 1 1	49	float RWES
<b>[id.S]</b> [ id.S]	<i>Loop (1)</i> <b>Idle Set Point</b> Set a closed loop set point that can be triggered by an event state.	Low Set Point to High Set Point (Setup Page)	75.0°F or units 24.0°C	Always	<b>Instance 1</b> <i>Map 1</i> <i>Map 2</i> 2176    2656	0x6B (107) 1 9	50	float RWES
<b>Note:</b> Some values will be rounded off to fit in the four-character display. Full values can be read with other inter- faces.								R: Read W: Write E: EEPROM S: User Set
* Available with PM4, PM8 and PM9 models only								

Operations Page

Display	Parameter name Description	Range	Default	Parameter Appears in Menu When	Modbus Rela- tive Address	CIP Class Instance Attribute hex (dec)	Profibus Index	Data Type & Read/ Write
<b>h.Pb</b> [ h.Pb]	<i>Loop (1)</i> <b>Heat Proportional Band</b> Set the PID proportional band for the heat outputs.	0.001 to 9,999.000°F or units -1,110.555 to 5,555.000°C	25.0°F or units 14.0°C	Heat Algorithm (Setup Page) is set to PID.	<b>Instance 1</b> <i>Map 1</i> <i>Map 2</i> 1890 2370	0x97 (151) 1 6	65	float RWES
<b>h.hy</b> [ h.hy]	<i>Loop (1)</i> <b>Heat Hysteresis</b> Set the control switching hysteresis for on-off control. This determines how far into the “on” region the process value needs to move before the output turns on.	0.001 to 9,999.000°F or units -1,110.555 to 5,555.000°C	3.0°F or units 2.0°C	Heat Algorithm (Setup Page) is set to On-Off.	<b>Instance 1</b> <i>Map 1</i> <i>Map 2</i> 1900 2380	0x97 (151) 1 0xB (11)	66	float RWES
<b>C.Pb</b> [ C.Pb]	<i>Loop (1)</i> <b>Cool Proportional Band</b> Set the PID proportional band for the cool outputs.	0.001 to 9,999.000°F or units -1,110.555 to 5,555.000°C	25.0°F or units 14.0°C	Cool Algorithm (Setup Page) is set to PID.	<b>Instance 1</b> <i>Map 1</i> <i>Map 2</i> 1892 2370	0x97 (151) 1 7	67	float RWES
<b>C.hy</b> [ C.hy]	<i>Loop (1)</i> <b>Cool Hysteresis</b> Set the control switching hysteresis for on-off control. This determines how far into the “on” region the process value needs to move before the output turns on.	0.001 to 9,999.000°F or units -1,110.555 to 5,555.000°C	3.0°F or units 2.0°C	Cool Algorithm (Setup Page) is set to On-Off.	<b>Instance 1</b> <i>Map 1</i> <i>Map 2</i> 1902 2382	0x97 (151) 1 0xC (12)	68	float RWES
<b>t.i</b> [ ti]	<i>Loop (1)</i> <b>Time Integral</b> Set the PID integral for the outputs.	0 to 9,999 seconds per repeat	180.0 seconds per re- peat	Heat Algorithm or Cool Algorithm (Setup Page) is set to PID.	<b>Instance 1</b> <i>Map 1</i> <i>Map 2</i> 1894 2374	0x97 (151) 1 8	69	float RWES
<b>t.d</b> [ td]	<i>Loop (1)</i> <b>Time Derivative</b> Set the PID derivative time for the outputs.	0 to 9,999 seconds	0.0 seconds	Heat Algorithm or Cool Algorithm (Setup Page) is set to PID.	<b>Instance 1</b> <i>Map 1</i> <i>Map 2</i> 1896 2376	0x97 (151) 1 9	70	float RWES
<b>db</b> [ db]	<i>Loop (1)</i> <b>Dead Band</b> Set the offset to the proportional band. With a negative value, both heating and cooling outputs are active when the process value is near the set point. A positive value keeps heating and cooling outputs from fighting each other.	-1,000.0 to 1,000.0°F or units -556 to 556°C	0.0	Always	<b>Instance 1</b> <i>Map 1</i> <i>Map 2</i> 1898 2378	0x97 (151) 1 0xA (10)	71	float RWES
<b>Note:</b> Some values will be rounded off to fit in the four-character display. Full values can be read with other interfaces.								R: Read W: Write E: EEPROM S: User Set
* Available with PM4, PM8 and PM9 models only								

Operations Page

Display	Parameter name Description	Range	Default	Parameter Appears in Menu When	Modbus Relative Address	CIP Class Instance Attribute hex (dec)	Profibus Index	Data Type & Read/Write
<input type="checkbox"/> <b>o.SP</b> [ o.SP]	<i>Loop (1)</i> <b>Open Loop Set Point</b> Set a fixed level of output power when in manual (open-loop) mode.	-100 to 100% (heat and cool) 0 to 100% (heat only) -100 to 0% (cool only)	0.0	Always	<b>Instance 1</b> <i>Map 1</i> <i>Map 2</i> 2162    2642	0x6B (107) 1 2	51	float RWES
<input type="checkbox"/> <b>ALP7</b> <input type="checkbox"/> <b>o.PEr</b> <b>Alarm Menu</b>								
<input type="checkbox"/> <b>ALo</b> [ A.Lo]	<i>Alarm (1 to 4)</i> <b>Low Set Point</b> If Alarm Type (Setup Page, Alarm Menu) is set to: <b>process</b> - set the process value that will trigger a low alarm. <b>deviation</b> - set the span of units from the closed loop set point that will trigger a low alarm. A negative set point represents a value below closed loop set point. A positive set point represents a value above closed loop set point.	-1,999.000 to 9,999.000°F or units -1,128.000 to 5,537.000°C	32.0°F or units 0.0°C	Alarm Sides (Setup Page) is not set to High.	<b>Instance 1</b> <i>Map 1</i> <i>Map 2</i> 1482    1882  Offset to next instance ( <i>Map 1</i> ) equals +50  Offset to next instance ( <i>Map 2</i> ) equals +60	0x6D (109) 1 to 4 2	18	float RWES
<input type="checkbox"/> <b>Ah</b> [ A.hi]	<i>Alarm (1 to 4)</i> <b>High Set Point</b> If Alarm Type (Setup Page, Alarm Menu) is set to: <b>process</b> - set the process value that will trigger a high alarm. <b>deviation</b> - set the span of units from the closed loop set point that will trigger a high alarm.	-1,999.000 to 9,999.000°F or units -1,128.000 to 5,537.000°C	300.0°F or units 150.0°C	Alarm Sides (Setup Page) is not set to Low.	<b>Instance 1</b> <i>Map 1</i> <i>Map 2</i> 1480    1880  Offset to next instance ( <i>Map 1</i> ) equals +50  Offset to next instance ( <i>Map 2</i> ) equals +60	0x6D (109) 1 to 4 1	19	float RWES
No Displayed	<i>Alarm (1 to 4)</i> <b>Alarm State</b> Current state of alarm	Startup (88) None (61) Blocked (12) Alarm low (8) Alarm high (7) Error (28)	None	No parameter	<b>Instance 1</b> <i>Map 1</i> <i>Map 2</i> 1496    1896  Offset to next instance [Map1 +50], [Map 2 +60]	0x6D (109) 1 to 4 9	----	uint R
<b>Note:</b> Some values will be rounded off to fit in the four-character display. Full values can be read with other interfaces.  * Available with PM4, PM8 and PM9 models only								R: Read W: Write E: EEPROM S: User Set

## Operations Page

Display	Parameter name Description	Range	Default	Parameter Appears in Menu When	Modbus Rela- tive Address	CIP Class Instance Attribute hex (dec)	Profibus Index	Data Type & Read/ Write
No Dis- played	<i>Alarm (1 to 4)</i> <b>Alarm Clearable</b> Current state of alarm	<input type="checkbox"/> <b>no</b> No (59) <input type="checkbox"/> <b>YES</b> Yes (106)	- - - -	No param- eter	<b>Instance 1</b> <i>Map 1</i> <i>Map 2</i> 1502 1902  Offset to next instance (Map1 1 equals +50, <i>Map 2</i> equals +60)	0x6D (109) 1 to 4 0xC (12)	- - - -	uint R
No Dis- played	<i>Alarm (1 to 4)</i> <b>Alarm Clear Re- quest</b> Write to this register to clear an alarm	Clear (1003)	0	No param- eter	<b>Instance 1</b> <i>Map 1</i> <i>Map 2</i> 1504 1904  Offset to next instance (Map1 1 equals +50, <i>Map 2</i> equals +60)	0x6D (109) 1 to 4 0xD (13)	- - - -	uint W
No Dis- played	<i>Alarm (1 to 4)</i> <b>Alarm Silence Re- quest</b> Write to this register to silence an alarm	Silence (1010)	0	No param- eter	<b>Instance 1</b> <i>Map 1</i> <i>Map 2</i> 1506 1906  Offset to next instance (Map1 1 equals +50, <i>Map 2</i> equals +60)	0x6D (109) 1 to 4 0xE (14)	- - - -	uint W
No Dis- played	<i>Alarm (1 to 4)</i> <b>Alarm Silenced</b> Write to this register to silence an alarm	Yes (106) No (59)	- - - -	No param- eter	<b>Instance 1</b> <i>Map 1</i> <i>Map 2</i> 1500 1900  Offset to next instance (Map1 1 equals +50, <i>Map 2</i> equals +60)	0x6D (109) 1 to 4 0x0B (11)	- - - -	uint R
No Dis- played	<i>Alarm (1 to 4)</i> <b>Alarm Latched</b> Write to this register to silence an alarm	Yes (106) No (59)	- - - -	No param- eter	<b>Instance 1</b> <i>Map 1</i> <i>Map 2</i> 1498 1898  Offset to next instance (Map1 1 equals +50, <i>Map 2</i> equals +60)	0x6D (109) 1 to 4 0x0A (10)	- - - -	uint R
<b>Note:</b> Some values will be rounded off to fit in the four-character display. Full values can be read with other inter- faces.  * Available with PM4, PM8 and PM9 models only								R: Read W: Write E: EEPROM S: User Set

Operations Page

Display	Parameter name Description	Range	Default	Parameter Appears in Menu When	Modbus Rela- tive Address	CIP Class Instance Attribute hex (dec)	Profibus Index	Data Type & Read/ Write	
<b>PSEr</b> <b>oPEr</b> <b>Profile Status Menu</b>  Profile Menu appears if: (PM _ [R, B*, N, E*] _ _ _ _ _ _ _ _ _ _ )				* Available with PM8/9 only * Some parameters in the Profile Status Menu can be changed for the currently running profile, but should only be changed by knowledgeable personnel and with caution. Changing parameters via the Profile Status Menu will not change the stored profile but will have an immediate impact on the profile that is running. Changes made to profile parameters in the Profiling Pages will be saved and will also have an immediate impact on the running profile.					
<b>PSEr</b> [P.Str]	<i>Profile Status</i> <b>Profile Start</b> Select step to act upon.	1 to 40	1	Always	<b>Instance 1</b> <i>Map 1</i> <i>Map 2</i> 2520   4340	0x7A (122) 1 1	204	uint RW	
<b>PACr</b> [PACr]	<i>Profile Status</i> <b>Action Request</b>	<b>none</b> None (61) <b>STEP</b> Step Start (89) <b>End</b> Terminate (148) <b>RESU</b> Resume (147) <b>PAUS</b> Pause (146) <b>ProF</b> Profile (77)	None	Always	<b>Instance 1</b> <i>Map 1</i> <i>Map 2</i> 2540   4360	0x7A (122) 1 0xB (11)	205	uint RW	
<b>SEP</b> [StP]	<i>Profile Status</i> <b>Active Step</b> View the currently running step.	1 to 40	0 (none)	a profile is active.	<b>Instance 1</b> <i>Map 1</i> <i>Map 2</i> 2526   4346	0x7A (122) 1 4	----	uint R	
<b>SEYP</b> [S.typ]	<i>Profile Status</i> <b>Active Step Type</b> View the currently running step type.	<b>USEP</b> Unused Step (50) <b>End</b> End (27) <b>JL</b> Jump Loop (116) <b>CLoC</b> Wait For Time (1543) <b>UJbo</b> Wait For Both (210) <b>UJPr</b> Wait For Process (209) <b>UJE</b> Wait For Event (144) <b>SoRH</b> Soak (87) <b>t</b> , Time (143) <b>rATE</b> Rate (81)	----	a profile is active.	<b>Instance 1</b> <i>Map 1</i> <i>Map 2</i> 2544   4364	0x7A (122) 1 0xD (13)	----	uint R	
<b>ESP1</b> [tg.SP]	<i>Profile Status</i> <b>*Target Set Point Loop 1</b> View or change the target set point of the current step.	-1,999.000 to 9,999.000°F or units -1,128.000 to 5,537.000°C	0.0°F or units -18.0°C	a profile is active.	<b>Instance 1</b> <i>Map 1</i> <i>Map 2</i> 2542   4502	0x7A (122) 1 0xC (12)	----	uint RW	
<b>ACSP</b> [AC.SP]	<i>Profile Status</i> <b>Produced Set Point 1</b> Display the current set point, even if the profile is ramping.	-1,999.000 to 9,999.000°F or units -1,128.000 to 5,537.000°C	0.0°F or units -18.0°C	Always	<b>Instance 1</b> <i>Map 1</i> <i>Map 2</i> -----	-----	----	float R	
<b>Note:</b> Some values will be rounded off to fit in the four-character display. Full values can be read with other inter- faces.									R: Read W: Write E: EEPROM S: User Set
* Available with PM4, PM8 and PM9 models only									

Operations Page

Display	Parameter name Description	Range	Default	Parameter Appears in Menu When	Modbus Rela- tive Address	CIP Class Instance Attribute hex (dec)	Profibus Index	Data Type & Read/ Write
<input type="checkbox"/> <b>SE</b> , [ S.ti]	<i>Profile Status</i> <b>*Step Time Remaining</b> View or change the time remaining for the current step. Step is displayed in seconds. If the time exceeds 9,999 seconds, the display will show 9,999 and remain there while the control continues to decrement internally. Once the remaining time is equal to or less than 9,999 the display will represent the actual seconds remaining. As an example, if a three-hour soak time is currently being monitored, the first value displayed will be 9,999, and the display will remain at 9,999 until the remaining time is approximately equal to 2 hours and 46 minutes. At this point the display will track the actual seconds remaining.	0 to 9,999.000 seconds	0	Always	<b>Instance 1</b> <i>Map 1</i> <i>Map 2</i> 2536    4356	0x7A (122) 1 9	----	float RW
<input type="checkbox"/> <b>Ent1</b> [Ent1]	<i>Profile Status</i> <b>Active Event Output 1</b> View or change the event output states.	<input type="checkbox"/> <b>oFF</b> Off (62) <input type="checkbox"/> <b>oN</b> On (63)	Off	Always	<b>Instance 1</b> <i>Map 1</i> <i>Map 2</i> 2546    4512	0x7A (122) 1 0xE (14)	----	uint RW
<input type="checkbox"/> <b>Ent2</b> [Ent2]	<i>Profile Status</i> <b>Active Event Output 2</b> View or change the event output states.	<input type="checkbox"/> <b>oFF</b> Off (62) <input type="checkbox"/> <b>oN</b> On (63)	Off	Always	<b>Instance 1</b> <i>Map 1</i> <i>Map 2</i> 2548    4514	0x7A (122) 1 0xF (15)	----	uint RW
<input type="checkbox"/> <b>JC</b> [ JC]	<i>Profile Status</i> <b>Jump Count Remaining</b> View the jump counts remaining for the current loop. In a profile with nested loops, this may not indicate the actual jump counts remaining.	0 to 9,999	0	Always	<b>Instance 1</b> <i>Map 1</i> <i>Map 2</i> 2538    4358	0x7A (122) 1 0xA (10)	----	uint R
No Display	<i>Profile Status</i> <b>Profile State</b> Read currentProfile state.	off (62) Running (149) Pause (146)	----	----	<b>Instance 1</b> <i>Map 1</i> <i>Map 2</i> 2522    4342	0x7A (122) 1 2	----	uint R
<b>Note:</b> Some values will be rounded off to fit in the four-character display. Full values can be read with other interfaces.								R: Read W: Write E: EEPROM S: User Set
* Available with PM4, PM8 and PM9 models only								

### Operations Page

Display	Parameter name Description	Range	Default	Parameter Appears in Menu When	Modbus Rela- tive Address	CIP Class Instance Attribute hex (dec)	Profibus Index	Data Type & Read/ Write
No Dis- play	<i>Profile Status</i> <b>Current File</b> Indicates current file being executed.	1 to 4	0	----	<b>Instance 1</b> <i>Map 1</i> <i>Map 2</i> 2524      4344	0x7A (122) 1 3	----	uint R
<b>Note:</b> Some values will be rounded off to fit in the four-character display. Full values can be read with other inter- faces.								R: Read W: Write E: EEPROM S: User Set
* Available with PM4, PM8 and PM9 models only								







# 6

## Chapter 6: Setup Page

### Navigating the Setup Page





To go to the Setup Page from the Home Page, press both the Up  and Down  keys for six seconds.



















 will appear in the upper display and  will appear in the lower display.





















- Press the Up  or Down  key to view available menus. On the following pages top level menus are identified with a yellow background color.
- Press the Advance Key  to enter and view available prompts within a menu.













#### Note:











Some of these menus and parameters may not appear, depending on the controller's options. See model number information in the Appendix for more information. If there is only one instance of a menu, no submenus will appear.















- Press the Up  or Down  key to move through available menu prompts.
- Press the Infinity Key  to move backwards through the levels: parameter to submenu; submenu to menu; menu to Home Page.
- Press and hold the Infinity Key  for two seconds to return to the Home Page.































 **SEE** Analog Input Menu  
  
 Analog Input  
 Sensor Type  
 Linearization  
 RTD Leads  
 Units  
 Scale Low  
 Scale High  
 Range Low  
 Range High  
 Process Error Enable  
 Process Error Low  
 Thermistor Curve  
 Resistance Range  
 Filter  
 Error Latching  
 Display Precision











\*  
**SEE** Linearization Menu  
  
 Linearization  
 Function  
 Units  
 Input Point 1  
 Output Point 1  
 Input Point 2  
 Output Point 2  
 Input Point 3  
 Output Point 3  
 Input Point 4  
 Output Point 4  
 Input Point 5  
 Output Point 5  
 Input Point 6  
 Output Point 6  
 Input Point 7  
 Output Point 7  
 Input Point 8

 Output Point 8  
 Input Point 9  
 Output Point 9  
 Input Point 10  
 Output Point 10  
\*  
**SEE** Process Value  
  
 Process Value  
 Function  
 Pressure Units  
 Altitude Units  
 Filter

  
**SEE** Digital Input/Output Menu  
 to   
 Digital Input/Output  
 Direction  
 Function  
 Function Instance  
 Control  
 Time Base  
 Low Power Scale  
 High Power Scale

  
**SEE** Control Loop Menu  
  
 Control Loop  
 Heat Algorithm  
 Cool Algorithm  
 Cool Output Curve  
 Tru-Tune+™ Enable  
 Tru-Tune+™ Band  
 Tru-Tune+™ Gain  
 Autotune Aggressiveness  
 Peltier Delay  
 Remote Set Point Enable  
 Remote Set Point Type  
 User Failure Action  
 Filter Error Failure

 Manual Power  
 Open Loop Detect Enable  
 Open Loop Detect Time  
 Open Loop Detect Deviation  
 Ramp Action  
 Ramp Scale  
 Ramp Rate  
 Low Set Point  
 High Set Point  
 Set Point Open Limit Low  
 Set Point Open Limit High  
  
**SEE** Output Menu  
 to   
 Output  
 Function  
 Function Instance  
 Control  
 Time Base  
 Low Power Scale  
 High Power Scale  
 Output 1 process  
 Type  
 Function  
 Function Instance  
 Scale Low  
 Scale High  
 Range Low  
 Range High  
 Calibration Offset

  
**SEE** Alarm Menu  
 to   
 Alarm  
 Type  
 Source Function A  
 Source Instance A  
 Hysteresis  
 Logic  
 Sides

\* Available with PM4, PM8 and PM9 models only



**R<sub>L</sub>A** Latching  
**R<sub>b</sub>L** Blocking  
**R<sub>S</sub> ,** Silencing  
**R<sub>d</sub>SP** Display  
**R<sub>d</sub>L** Delay

**FUn**

**SEE** Function Key Menu

**1** to **2**

**FUn** Function Key

**LE<sub>u</sub>** Level

**F<sub>n</sub>** Digital Input Function

**F ,** Instance

**GLbL**

**SEE** Global Menu

**1**

**GLbL** Global

**C<sub>-</sub>F** Display Units

**ACLF** AC Line Frequency

**r<sub>t</sub>YP** Ramping Type

**P<sub>t</sub>YP** Profile type

**gSE** Guaranteed Soak Enable

**gSD<sub>1</sub>** Guaranteed Soak Deviation 1

**gSD<sub>2</sub>** Guaranteed Soak Deviation 2

**S<sub>a</sub>** Source instance A

**S<sub>b</sub>** Source instance B

**PO<sub>t</sub> ,** Power Out Time

**CL<sub>E</sub>d** Communications LED Action

**Z<sub>o</sub>nE** Zone Action

**Ch<sub>R</sub>n** Channel Action

**dPr<sub>S</sub>** Display Pairs

**d<sub>t</sub> ,** Menu Display Timer

**CO<sub>PP</sub>**

**SEE** Communications Menu

**1**

**CO<sub>PP</sub>** Communications

**P<sub>C</sub>oL** Protocol

**R<sub>d</sub>S** Standard Bus Address

**R<sub>d</sub>PP** Modbus Address

**b<sub>R</sub>Ud** Baud Rate

**P<sub>R</sub>r** Parity

**PP<sub>h</sub>L** Modbus Word Order

**PP<sub>R</sub>P** Data Map

**n<sub>v</sub>S** Non-volatile Save

**r<sub>t</sub>C\***

**SEE** Real Time Clock

**h<sub>o</sub>U<sub>r</sub>** Hour

**PP<sub>i</sub>n** Minute

**d<sub>o</sub>W** Day of Week

\* Available with PM8 and PM9 models only

Setup Page

Display	Parameter name Description	Range	Default	Parameter Appears in Menu When	Modbus Rela- tive Address	CIP Class Instance Attribute hex (dec)	Profibus Index	Data Type & Read/ Write
<div style="border: 1px solid black; padding: 2px;"> <input type="checkbox"/> <b>A</b>    <input type="checkbox"/> <b>SEt</b>  <b>Analog Input Menu</b> </div>								
<input type="checkbox"/> <b>SEn</b> [SEn]	<b>Analog Input (1)</b> <b>Sensor Type</b> Set the analog sensor type to match the device wired to this input.  <b>Note:</b> There is no open-sensor detection for process inputs.	<input type="checkbox"/> <b>oFF</b> Off (62) <input type="checkbox"/> <b>tC</b> Thermocouple (95) <input type="checkbox"/> <b>mVdc</b> Millivolts (56) <input type="checkbox"/> <b>vdc</b> Volts dc (104) <input type="checkbox"/> <b>mA</b> Milliamps dc (112) <input type="checkbox"/> <b>RTD 100</b> RTD 100 Ω (113) <input type="checkbox"/> <b>RTD 1000</b> RTD 1,000 Ω (114) <input type="checkbox"/> <b>Pot</b> Potentiometer 1 kΩ (155) <input type="checkbox"/> <b>Ther</b> Thermistor (229)		Always	<b>Instance 1</b> <i>Map 1</i> <i>Map 2</i> 368      368	0x68 (104) 1 5	3	uint RWES
<input type="checkbox"/> <b>Lin</b> [Lin]	<b>Analog Input (1)</b> <b>Linearization</b> Set the linearization to match the thermocouple wired to this input.	<input type="checkbox"/> <b>B</b> B (11) <input type="checkbox"/> <b>K</b> K (48) <input type="checkbox"/> <b>C</b> C (15) <input type="checkbox"/> <b>N</b> N (58) <input type="checkbox"/> <b>D</b> D (23) <input type="checkbox"/> <b>R</b> R (80) <input type="checkbox"/> <b>E</b> E (26) <input type="checkbox"/> <b>S</b> S (84) <input type="checkbox"/> <b>F</b> F (30) <input type="checkbox"/> <b>T</b> T (93) <input type="checkbox"/> <b>J</b> J (46)	J	Sensor Type is set to Thermocouple.	<b>Instance 1</b> <i>Map 1</i> <i>Map 2</i> 370      370	0x68 (104) 1 6	4	uint RWES
<input type="checkbox"/> <b>rtL</b> [rt.L]	<b>Analog Input (1)</b> <b>RTD Leads</b> Set to match the number of leads on the RTD wired to this input.	<input type="checkbox"/> <b>2</b> 2 (1) <input type="checkbox"/> <b>3</b> 3 (2)	2	Sensor Type is set to RTD 100 Ω or RTD 1,000 Ω.	<b>Instance 1</b> <i>Map 1</i> <i>Map 2</i> 372      368	0x68 (104) 1 7	----	uint RWES
<input type="checkbox"/> <b>Unit</b> [Unit]	<b>Analog Input (1)</b> <b>Units</b> Set the type of units the sensor will measure.	<input type="checkbox"/> <b>Temp</b> Absolute Temperature (1540) <input type="checkbox"/> <b>rh</b> Relative Humidity (1538) <input type="checkbox"/> <b>Proc</b> Process (75) <input type="checkbox"/> <b>Power</b> Power (73)	Process	Sensor Type is set to Millivolts, Volts, Milliamps or Potentiometer 1 kΩ.	<b>Instance 1</b> <i>Map 1</i> <i>Map 2</i> ----      442	0x68 (104) 1 0x2A (42)	5	uint RWES
<input type="checkbox"/> <b>SLo</b> [S.Lo]	<b>Analog Input (1)</b> <b>Scale Low</b> Set the low scale for process inputs. This value, in millivolts, volts or milliamps, will correspond to the Range Low output of this function block.	-100.0 to 1,000.0	0.0	Sensor Type is set to Millivolts, Volts, Milliamps or Potentiometer 1 kΩ.	<b>Instance 1</b> <i>Map 1</i> <i>Map 2</i> 388      388	0x68 (104) 1 0xF (15)	6	float RWES
<b>Note:</b> Some values will be rounded off to fit in the four-character display. Full values can be read with other interfaces.  * Available with PM4, PM8 and PM9 models only								R: Read W: Write E: EE-PROM S: User Set

Setup Page

Display	Parameter name Description	Range	Default	Parameter Appears in Menu When	Modbus Relative Address	CIP Class Instance Attribute hex (dec)	Profibus Index	Data Type & Read/Write
<u>S.h</u> [ S.hi]	<i>Analog Input (1)</i> <b>Scale High</b> Set the high scale for process inputs. This value, in millivolts, volts or milliamps, will correspond to the Range High output of this function block.	-100.0 to 1,000.0	20.0	Sensor Type is set to Millivolts, Volts, Milliamps or Potentiometer 1 kΩ.	<b>Instance 1</b> <i>Map 1</i> <i>Map 2</i> 390      390	0x68 (104) 1 0x10 (16)	7	float RWES
<u>r.Lo</u> [ r.Lo]	<i>Analog Input (1)</i> <b>Range Low</b> Set the low range for this function block's output.	-1,999.000 to 9,999.000	0.0	Sensor Type is set to Millivolts, Volts, Milliamps or Potentiometer 1 kΩ.	<b>Instance 1</b> <i>Map 1</i> <i>Map 2</i> 392      392	0x68 (104) 1 0x11 (17)	8	float RWES
<u>r.hi</u> [ r.hi]	<i>Analog Input (1)</i> <b>Range High</b> Set the high range for this function block's output.	-1,999.000 to 9,999.000	9,999	Sensor Type is set to Millivolts, Volts, Milliamps or Potentiometer 1 kΩ.	<b>Instance 1</b> <i>Map 1</i> <i>Map 2</i> 394      394	0x68 (104) 1 0x12 (18)	9	float RWES
<u>PEE</u> [ P.EE]	<i>Analog Input (1)</i> <b>Process Error Enable</b> Turn the Process Error Low feature on or off.	<u>OFF</u> Off (62) <u>LOW</u> Low (53)	Off	Sensor Type is set to Millivolts, Volts, Milliamps or Potentiometer 1 kΩ.	<b>Instance 1</b> <i>Map 1</i> <i>Map 2</i> 418      388	0x68 (104) 1 0x1E (30)	10	uint RWES
<u>PEL</u> [ P.EL]	<i>Analog Input (1)</i> <b>Process Error Low</b> If the process value drops below this value, it will trigger an input error.	-100.0 to 1,000.0	0.0	Sensor Type is set to Millivolts, Volts, Milliamps or Potentiometer 1 kΩ, and Error Enable is set to Low.	<b>Instance 1</b> <i>Map 1</i> <i>Map 2</i> 420      420	0x68 (104) 1 0x1F (31)	11	float RWES
<u>t.C</u> [ t.C]	<i>Analog Input (1)</i> <b>Thermistor Curve</b> Select a curve to apply to the thermistor input.	<u>A</u> Curve A (1451) <u>B</u> Curve B (1452) <u>C</u> Curve C (1453) <u>USE</u> Custom (180)	Curve A	Sensor Type is set to Thermistor.	<b>Instance 1</b> <i>Map 1</i> <i>Map 2</i> 434      434	0x68 (104) 1 20x6 (38)	----	uint RWES
<u>r.r</u> [ r.r]	<i>Analog Input (1)</i> <b>Resistance Range</b> Set the maximum resistance of the thermistor input.	<u>5</u> 5K (1448) <u>10</u> 10K (1360) <u>20</u> 20K (1361) <u>40</u> 40K (1449)	40K	Sensor Type is set to Thermistor.	<b>Instance 1</b> <i>Map 1</i> <i>Map 2</i> 432      432	0x68 (104) 1 0x25 (37)	----	uint RWES
<b>Note:</b> Some values will be rounded off to fit in the four-character display. Full values can be read with other interfaces.  * Available with PM4, PM8 and PM9 models only								R: Read W: Write E: EE-PROM S: User Set

Setup Page

Display	Parameter name Description	Range	Default	Parameter Appears in Menu When	Modbus Rela- tive Address	CIP Class Instance Attribute hex (dec)	Profibus Index	Data Type & Read/ Write
<b>[ FiL ]</b> [ FiL]	<i>Analog Input (1)</i> <b>Filter</b> Filtering smooths out the process signal to both the display and the input. Increase the time to increase filtering.	0.0 to 60.0 seconds	0.5	Always	<b>Instance 1</b> Map 1    Map 2 386       386	0x68 (104) 1 0xE (14)	12	float RWES
<b>[ i.Er ]</b> [ i.Er]	<i>Analog Input (1)</i> <b>Error Latching</b> Turn input error latching on or off. If latching is on, errors must be manually cleared.	<b>[ OFF ]</b> Off (62) <b>[ ON ]</b> On (63)	Off	Always	<b>Instance 1</b> Map 1    Map 2 414       414	0x68 (104) 1 0x1C (28)	----	uint RWES
<b>[ Lnc ]*</b> <b>[ SEt ]</b> <b>Linearization Menu</b>								
<b>[ Fn ]</b> [ Fn]	<i>Linearization (1)</i> <b>Function</b> Set how this function will linearize Source A which is Analog Input 1.	<b>[ OFF ]</b> Off (62) <b>[ int ]</b> Interpolated (1482)	Off	Always if part number digit 4 is C, R, J, B, E or N.  PM8 and 9 only	<b>Instance 1</b> Map 1    Map 2 ----     3568	0x86 (134) 1 5	155	uint RWES
<b>[ Unit ]</b> [Unit]	<i>Linearization (1)</i> <b>Units</b> Set the units of Source A which is Analog Input 1.	<b>[ none ]</b> None (61) <b>[ Src ]</b> Source (1539) <b>[ rh ]</b> Relative Humidity (1538) <b>[ Proc ]</b> Process (75) <b>[ Power ]</b> Power (73) <b>[ rTP ]</b> Relative Temperature (1541) <b>[ AT ]</b> Absolute Temperature (1540)	Source	Always	<b>Instance 1</b> Map 1    Map 2 ----     3616	0x86 (134) 1 0x29 (41)	156	uint RWES
<b>[ ip.1 ]</b> [ ip.1]	<i>Linearization (1)</i> <b>Input Point 1</b> Set the value that will be mapped to output 1.	-1,999.000 to 9,999.000	0.0	Always	<b>Instance 1</b> Map 1    Map 2 ----     3574	0x86 (134) 1 8	157	float RWES
<b>[ op.1 ]</b> [ op.1]	<i>Linearization (1)</i> <b>Output Point 1</b> Set the value that will be mapped to input 1.	-1,999.000 to 9,999.000	0.0	Always	<b>Instance 1</b> Map 1    Map 2 ----     3594	0x86 (134) 1 0x12 (18)	158	float RWES
<b>[ ip.2 ]</b> [ ip.2]	<i>Linearization (1)</i> <b>Input Point 2</b> Set the value that will be mapped to output 2.	-1,999.000 to 9,999.000	1.0	Always	<b>Instance 1</b> Map 1    Map 2 ----     3576	0x86 (134) 1 9	159	float RWES
<b>[ op.2 ]</b> [ op.2]	<i>Linearization (1)</i> <b>Output Point 2</b> Set the value that will be mapped to input 2.	-1,999.000 to 9,999.000	1.0	Always	<b>Instance 1</b> Map 1    Map 2 ----     3597	0x86 (134) 1 0x13 (19)	160	float RWES
<b>Note:</b> Some values will be rounded off to fit in the four-character display. Full values can be read with other interfaces.  * Available with PM4, PM8 and PM9 models only								<b>R:</b> Read <b>W:</b> Write <b>E:</b> EE-PROM <b>S:</b> User Set

## Setup Page

Display	Parameter name Description	Range	Default	Parameter Appears in Menu When	Modbus Relative Address	CIP Class Instance Attribute hex (dec)	Profibus Index	Data Type & Read/ Write
<input type="checkbox"/> <b>.P.3</b> [ ip.3]	<i>Linearization (1)</i> <b>Input Point 3</b> Set the value that will be mapped to output 3.	-1,999.000 to 9,999.000	2.0	Always	<b>Instance 1</b> Map 1    Map 2 ----    3578	0x86 (134) 1 0xA (10)	161	float RWES
<input type="checkbox"/> <b>.o.P.3</b> [ op.3]	<i>Linearization (1)</i> <b>Output Point 3</b> Set the value that will be mapped to input 3.	-1,999.000 to 9,999.000	2.0	Always	<b>Instance 1</b> Map 1    Map 2 ----    3598	0x86 (134) 1 0x14 (20)	162	float RWES
<input type="checkbox"/> <b>.P.4</b> [ ip.4]	<i>Linearization (1)</i> <b>Input Point 4</b> Set the value that will be mapped to output 4.	-1,999.000 to 9,999.000	3.0	Always	<b>Instance 1</b> Map 1    Map 2 ----    3581	0x86 (134) 1 0xB (11)	163	float RWES
<input type="checkbox"/> <b>.o.P.4</b> [ op.4]	<i>Linearization (1)</i> <b>Output Point 4</b> Set the value that will be mapped to input 4.	-1,999.000 to 9,999.000	3.0	Always	<b>Instance 1</b> Map 1    Map 2 ----    3600	0x86 (134) 1 0x15 (21)	164	float RWES
<input type="checkbox"/> <b>.P.5</b> [ ip.5]	<i>Linearization (1)</i> <b>Input Point 5</b> Set the value that will be mapped to output 5.	-1,999.000 to 9,999.000	4.0	Always	<b>Instance 1</b> Map 1    Map 2 ----    3582	0x86 (134) 1 0xC (12)	165	float RWES
<input type="checkbox"/> <b>.o.P.5</b> [ op.5]	<i>Linearization (1)</i> <b>Output Point 5</b> Set the value that will be mapped to input 5.	-1,999.000 to 9,999.000	4.0	Always	<b>Instance 1</b> Map 1    Map 2 ----    3602	0x86 (134) 1 0x16 (22)	166	float RWES
<input type="checkbox"/> <b>.P.6</b> [ ip.6]	<i>Linearization (1)</i> <b>Input Point 6</b> Set the value that will be mapped to output 6.	-1,999.000 to 9,999.000	5.0	Always	<b>Instance 1</b> Map 1    Map 2 ----    3584	0x86 (134) 1 0xD (13)	167	float RWES
<input type="checkbox"/> <b>.o.P.6</b> [ op.6]	<i>Linearization (1)</i> <b>Output Point 6</b> Set the value that will be mapped to input 6.	-1,999.000 to 9,999.000	5.0	Always	<b>Instance 1</b> Map 1    Map 2 ----    3604	0x86 (134) 1 0x17 (23)	168	float RWES
<input type="checkbox"/> <b>.P.7</b> [ ip.7]	<i>Linearization (1)</i> <b>Input Point 7</b> Set the value that will be mapped to output 7.	-1,999.000 to 9,999.000	6.0	Always	<b>Instance 1</b> Map 1    Map 2 ----    3586	0x86 (134) 1 0xE (14)	169	float RWES
<input type="checkbox"/> <b>.o.P.7</b> [ op.7]	<i>Linearization (1)</i> <b>Output Point 7</b> Set the value that will be mapped to input 7.	-1,999.000 to 9,999.000	6.0	Always	<b>Instance 1</b> Map 1    Map 2 ----    3606	0x86 (134) 1 0x18 (24)	170	float RWES
<input type="checkbox"/> <b>.P.8</b> [ ip.8]	<i>Linearization (1)</i> <b>Input Point 8</b> Set the value that will be mapped to output 8.	-1,999.000 to 9,999.000	7.0	Always	<b>Instance 1</b> Map 1    Map 2 ----    3588	0x86 (134) 1 0xF (15)	171	float RWES
<b>Note:</b> Some values will be rounded off to fit in the four-character display. Full values can be read with other interfaces.  * Available with PM4, PM8 and PM9 models only								<b>R:</b> Read <b>W:</b> Write <b>E:</b> EE-PROM <b>S:</b> User Set

Setup Page

Display	Parameter name Description	Range	Default	Parameter Appears in Menu When	Modbus Rela- tive Address	CIP Class Instance Attribute hex (dec)	Profibus Index	Data Type & Read/ Write
<input type="checkbox"/> <b>oP.8</b> [ op.8]	<i>Linearization (1)</i> <b>Output Point 8</b> Set the value that will be mapped to input 8.	-1,999.000 to 9,999.000	7.0	Always	<b>Instance 1</b> Map 1    Map 2 ----    3608	0x86 (134) 1 0x19 (25)	172	float RWES
<input type="checkbox"/> <b>,P.9</b> [ ip.9]	<i>Linearization (1)</i> <b>Input Point 9</b> Set the value that will be mapped to output 9.	-1,999.000 to 9,999.000	8.0	Always	<b>Instance 1</b> Map 1    Map 2 ----    3590	0x86 (134) 1 0x10 (16)	173	float RWES
<input type="checkbox"/> <b>oP.9</b> [ op.9]	<i>Linearization (1)</i> <b>Output Point 9</b> Set the value that will be mapped to input 9.	-1,999.000 to 9,999.000	8.0	Always	<b>Instance 1</b> Map 1    Map 2 ----    3610	0x86 (134) 1 0x1A (26)	174	float RWES
<input type="checkbox"/> <b>,P.10</b> [ ip.10]	<i>Linearization (1)</i> <b>Input Point 10</b> Set the value that will be mapped to output 10.	-1,999.000 to 9,999.000	9.0	Always	<b>Instance 1</b> Map 1    Map 2 ----    3592	0x86 (134) 1 0x11 (17)	175	float RWES
<input type="checkbox"/> <b>oP.10</b> [ op.10]	<i>Linearization (1)</i> <b>Output Point 10</b> Set the value that will be mapped to input 10.	-1,999.000 to 9,999.000	9.0	Always	<b>Instance 1</b> Map 1    Map 2 ----    3612	0x86 (134) 1 0x1B (27)	176	float RWES
<input type="checkbox"/> <b>P.u</b> * <input type="checkbox"/> <b>SEt</b> <b>Process Value</b>								
<input type="checkbox"/> <b>F.n</b> [ Fn]	<i>Process Value (1)</i> <b>Function</b> Set the function that will be applied to the source or sources.	<input type="checkbox"/> <b>oFF</b> Off (62) <input type="checkbox"/> <b>ALt</b> *Pressure to Altitude (1649)	Off	Always if part number digit 4 is C, R, J, B, E or N.  PM8 and 9 only	<b>Instance 1</b> Map 1    Map 2 ----    3320	0x7E (126) 1 0x15 (21)	123	uint RWES
<input type="checkbox"/> <b>P.unT</b> [P.unt]	<i>Process Value (1)</i> <b>Pressure Units</b> Set the units that will be applied to the source.	<input type="checkbox"/> <b>PSI</b> Pounds per Square Inch (1671) <input type="checkbox"/> <b>PRSc</b> Pascal (1674) <input type="checkbox"/> <b>REAt</b> Atmosphere (1675) <input type="checkbox"/> <b>Pmb</b> Millibar (1672) <input type="checkbox"/> <b>torr</b> Torr (1673)	PSI	Always	<b>Instance 1</b> Map 1    Map 2 ----    3334	0x7E (126) 1 0x1C (28)	----	uint RWES
<input type="checkbox"/> <b>A.unT</b> [A.unt]	<i>Process Value (1)</i> <b>Altitude Units</b> Set the units that will be applied to the source.	<input type="checkbox"/> <b>HFE</b> Kilofeet (1677) <input type="checkbox"/> <b>FE</b> Feet (1676)	HFt	Always	<b>Instance 1</b> Map 1    Map 2 ----    3336	0x7E (126) 1 0x1D (29)	----	uint RWES
<b>Note:</b> Some values will be rounded off to fit in the four-character display. Full values can be read with other interfaces.  * Available with PM4, PM8 and PM9 models only								R: Read W: Write E: EE-PROM S: User Set

\* Pressure Altitude calculation is based on the International Standard Atmosphere, 1976

Setup Page

Display	Parameter name Description	Range	Default	Parameter Appears in Menu When	Modbus Relative Address	CIP Class Instance Attribute hex (dec)	Profibus Index	Data Type & Read/ Write
<b>FIL</b> [ FiL]	<i>Process Value (1)</i> <b>Filter</b> Filtering smooths out the output signal of this function block. Increase the time to increase filtering.	0.0 to 60.0 seconds	0.0	Always	<b>Instance 1</b> <i>Map 1</i> <i>Map 2</i> ----   3330	0x7E (126) 1 0x1A (26)	----	float RWES
<b>d.i.o</b> <b>SEt</b> <b>Digital Input/Output Menu</b>								
<b>dir</b> [ dir]	<i>Digital Input/Output (5 to 6)</i> <b>Direction</b> Set this function to operate as an input or output.	<b>OFF</b> Output (68) <b>Con</b> Input Dry Contact (44) <b>in</b> Input Voltage (193)	Output	Always	<b>Instance 1</b> <i>Map 1</i> <i>Map 2</i> 1000   1120  Offset to next instance ( <i>Map 1</i> & <i>Map 2</i> ) equals +30	0x6A (106) 5 to 6 1	82	uint RWES
<b>Fn</b> [ Fn]	<i>Digital Output (5 to 6)</i> <b>Action Function</b> Select what function will drive this output.	<b>OFF</b> Off (62) <b>Lim</b> Limit (126) <b>EntB</b> Profile Event Out B (234) <b>EntA</b> Profile Event Out A (233) <b>Sof2</b> Special Function Output 2 (1533) <b>Sof1</b> Special Function Output 1 (1532) <b>Cool</b> Cool Power, Control Loop (161) <b>Heat</b> Heat Power, Control Loop (160) <b>Alm</b> Alarm (6)	Off	Direction is set to Output.	<b>Instance 1</b> <i>Map 1</i> <i>Map 2</i> 1008   1128  Offset to next instance ( <i>Map 1</i> & <i>Map 2</i> ) equals +30	0x6A (106) 1 to 2 5	83	uint RWES
<b>Fi</b> [ Fi]	<i>Digital Output (5 to 6)</i> <b>Function Instance</b> Set the instance of the function selected above.	1 to 4	1	Direction is set to Output.	<b>Instance 1</b> <i>Map 1</i> <i>Map 2</i> 1010   1130  Offset to next instance ( <i>Map 1</i> & <i>Map 2</i> ) equals +30	0x6A (106) 5 to 6 6	84	uint RWES
<b>oCt</b> [ o.Ct]	<i>Digital Output (5 to 6)</i> <b>Control</b> Set the output control type. This parameter is only used with PID control, but can be set anytime.	<b>Ftb</b> Fixed Time Base (34) <b>Vtb</b> Variable Time Base (103)	Fixed Time Base	Direction is set to Output.	<b>Instance 1</b> <i>Map 1</i> <i>Map 2</i> 1002   1122  Offset to next instance ( <i>Map 1</i> & <i>Map 2</i> ) equals +30	0x6A (106) 5 to 6 2	85	uint RWES
<b>Note:</b> Some values will be rounded off to fit in the four-character display. Full values can be read with other interfaces.  * Available with PM4, PM8 and PM9 models only								R: Read W: Write E: EE-PROM S: User Set



Setup Page

Display	Parameter name Description	Range	Default	Parameter Appears in Menu When	Modbus Rela- tive Address	CIP Class Instance Attribute hex (dec)	Profibus Index	Data Type & Read/ Write
<u>o.t.b</u> [ o.tb ]	<i>Digital Output (5 to 6)</i> <b>Time Base</b> Set the time base for fixed-time-base control.	[ 0.1 for Fast and Bi-Directional outputs, 5.0 for Slow outputs] to 60	----	Control is set to Fixed Time Base.	<b>Instance 1</b> <i>Map 1</i> <i>Map 2</i> 1016   1124  Offset to next instance ( <i>Map 1 &amp; Map 2</i> ) equals +30	0x6A (106) 5 to 6 3	86	float RWES
<u>o.l.o</u> [ o.Lo ]	<i>Digital Output (5 to 6)</i> <b>Low Power Scale</b> The power output will never be less than the value specified and will represent the value at which output scaling begins.	0.0 to 100.0	0.0	Direction is set to Output and Source is set to Heat or Cool.	<b>Instance 1</b> <i>Map 1</i> <i>Map 2</i> 1016   1136  Offset to next instance ( <i>Map 1 &amp; Map 2</i> ) equals +30	0x6A (106) 5 to 6 9	87	float RWES
<u>o.h.i</u> [ o.hi ]	<i>Digital Output (5 to 6)</i> <b>High Power Scale</b> The power output will never be greater than the value specified and will represent the value at which output scaling stops.	0.0 to 100.0	100.0	Direction is set to Output and Source is set to Heat or Cool.	<b>Instance 1</b> <i>Map 1</i> <i>Map 2</i> 1018   1138  Offset to next instance ( <i>Map 1 &amp; Map 2</i> ) equals +30	0x6A (106) 5 to 6 0xA (10)	88	float RWES
<u>l.E.v</u> [ LEv ]	<i>Digital Input (5 to 6)</i> <b>Level</b> Select which action will be interpreted as a true state.	<u>h.i.h</u> High (37) <u>l.o.l</u> Low (53)	High	Direction is set to input	<b>Instance 1</b> <i>Map 1</i> <i>Map 2</i> 1320   1560  Offset to next instance ( <i>Map 1 &amp; Map 2</i> ) equals +20	0x6E (110) 5 to 6 1	137	uint RW
<b>Note:</b> Some values will be rounded off to fit in the four-character display. Full values can be read with other interfaces.  * Available with PM4, PM8 and PM9 models only								R: Read W: Write E: EE-PROM S: User Set

Setup Page

Display	Parameter name Description	Range	Default	Parameter Appears in Menu When	Modbus Relative Address	CIP Class Instance Attribute hex (dec)	Profibus Index	Data Type & Read/Write	
<input type="checkbox"/> Fn [ Fn]	<b>Digital Input (5 to 6)</b> <b>Action Function</b> Select the function that will be triggered by a true state for Digital Input 5 and or 6.	<input type="checkbox"/> None None (61) <input type="checkbox"/> PSES Profile Start/Stop, level triggered (208) <input type="checkbox"/> PROF Profile Start Number, edge triggered (196) <input type="checkbox"/> PHOL Profile Hold/Resume, level triggered (207) <input type="checkbox"/> PDIS Profile Disable, level triggered (206) <input type="checkbox"/> EDRA TRU-TUNE+® Disable, level triggered (219) <input type="checkbox"/> OFF Control Outputs Off, level triggered (90) <input type="checkbox"/> MAN Manual/Auto Mode, level triggered (54) <input type="checkbox"/> TUNE Tune, edge triggered (98) <input type="checkbox"/> IDLE Idle Set Point Enable, level triggered (107) <input type="checkbox"/> FAL Force Alarm, level triggered (218) <input type="checkbox"/> AOF Alarm Outputs & Control Loop Off, level triggered (220) <input type="checkbox"/> SIL Silence Alarms, edge triggered (108) <input type="checkbox"/> ALR Alarm Reset, edge triggered (6) <input type="checkbox"/> PLOC Lock Keypad, level triggered (217) <input type="checkbox"/> USR Restore User Settings, edge triggered (227) <input type="checkbox"/> LRR Limit Reset, edge triggered (82)	None	Direction is set to Output.	<b>Instance 1</b> Map 1    Map 2 1324    1564  Offset to next instance (Map 1 & Map 2) equals +20	0x6E (110) 1 to 2 3	138	uint RWES	
<input type="checkbox"/> Fi [ Fi]	<b>Digital Input (5 to 7)</b> <b>Function Instance</b> Select which Digital Input will be triggered by a true state.	0 to 4	0	Direction is set to Output.	<b>Instance 1</b> Map 1    Map 2 1326    1566  Offset to next instance (Map 1 & Map 2) equals +20	0x6E (110) 5 to 7 4	139	uint RWES	
<input type="checkbox"/> Loop <input type="checkbox"/> Set <b>Control Loop Menu</b>									
<input type="checkbox"/> hAg [ h.Ag]	<b>Control Loop (1)</b> <b>Heat Algorithm</b> Set the heat control method.	<input type="checkbox"/> OFF Off (62) <input type="checkbox"/> PID PID (71) <input type="checkbox"/> ONOFF On-Off (64)	PID	Always	<b>Instance 1</b> Map 1    Map 2 1884    2364	0x97 (151) 1 3	72	uint RWES	
<b>Note:</b> Some values will be rounded off to fit in the four-character display. Full values can be read with other interfaces.  * Available with PM4, PM8 and PM9 models only									R: Read W: Write E: EE-PROM S: User Set

Setup Page

Display	Parameter name Description	Range	Default	Parameter Appears in Menu When	Modbus Rela- tive Address	CIP Class Instance Attribute hex (dec)	Profibus Index	Data Type & Read/ Write
<b>[C.Ag]</b> [ C.Ag]	<i>Control Loop (1)</i> <b>Cool Algorithm</b> Set the cool control method.	<b>[OFF]</b> Off (62) <b>[PID]</b> PID (71) <b>[OnOff]</b> On-Off (64)	Off	Always	<b>Instance 1</b> <i>Map 1</i> <i>Map 2</i> 1886 2366	0x97 (151) 1 4	73	uint RWES
<b>[C.Cr]</b> [ C.Cr]	<i>Control Loop (1)</i> <b>Cool Output Curve</b> Select a cool output curve to change the responsiveness of the system.	<b>[OFF]</b> Off (62) <b>[CrA]</b> Non-linear Curve 1 (214) <b>[CrB]</b> Non-linear Curve 2 (215)	Off	Cool Algorithm is set to PID.	<b>Instance 1</b> <i>Map 1</i> <i>Map 2</i> 1888 2368	0x97 (151) 1 5	----	uint RWES
<b>[t.tUn]</b> [t.tUn]	<i>Control Loop (1)</i> <b>TRU-TUNE+™ Enable</b> Enable or disable the TRU-TUNE+™ adaptive tuning feature.	<b>[no]</b> No (59) <b>[YES]</b> Yes (106)	No	Cool Algorithm or Heat Algorithm is set to PID.	<b>Instance 1</b> <i>Map 1</i> <i>Map 2</i> 1910 2390	0x97 (151) 1 0x10 (16)	----	uint RWES
<b>[t.bnd]</b> [t.bnd]	<i>Control Loop (1)</i> <b>TRU-TUNE+™ Band</b> Set the range, centered on the set point, within which TRU-TUNE+™ will be in effect. Use this function only if the controller is unable to adaptive tune automatically.	0 to 100	0	Cool Algorithm or Heat Algorithm is set to PID and TRU-TUNE+™ Enable is set to Yes.	<b>Instance 1</b> <i>Map 1</i> <i>Map 2</i> 1912 2392	0x97 (151) 1 0x11 (17)	----	uint RWES
<b>[t.gn]</b> [ t.gn]	<i>Control Loop (1)</i> <b>TRU-TUNE+™ Gain</b> Select the responsiveness of the TRU-TUNE+™ adaptive tuning calculations. More responsiveness may increase overshoot.	1 to 6	3	Cool Algorithm or Heat Algorithm is set to PID and TRU-TUNE+™ Enable is set to Yes.	<b>Instance 1</b> <i>Map 1</i> <i>Map 2</i> 1914 2394	0x97 (151) 1 0x12 (18)	----	uint RWES
<b>[t.Agr]</b> [t.Agr]	<i>Control Loop (1)</i> <b>Autotune Aggressiveness</b> Select the aggressiveness of the autotuning calculations.	<b>[Undr]</b> Under damped (99) <b>[CrIt]</b> Critical damped (21) <b>[Over]</b> Over damped (69)	Critical	Cool Algorithm or Heat Algorithm is set to PID.	<b>Instance 1</b> <i>Map 1</i> <i>Map 2</i> 1916 2396	0x97 (151) 1 0x13 (19)	----	uint RWES
<b>[P.dL]</b> [ P.dL]	<i>Control Loop (1)</i> <b>Peltier Delay</b> Set a value that will cause a delay when switching from heat mode to cool mode.	0.0 to 5.0	0.0	When the Cool and Heat algorithm are set on.	<b>Instance 1</b> <i>Map 1</i> <i>Map 2</i> -----	0x97 (151) 1 0x1C (28)	----	float RWES
<b>Note:</b> Some values will be rounded off to fit in the four-character display. Full values can be read with other interfaces.  * Available with PM4, PM8 and PM9 models only								R: Read W: Write E: EE-PROM S: User Set

Setup Page

Display	Parameter name Description	Range	Default	Parameter Appears in Menu When	Modbus Relative Address	CIP Class Instance Attribute hex (dec)	Profibus Index	Data Type & Read/Write
<b>[UFA]</b> [UFA]	<b>Control Loop (1)</b> <b>User Failure Action</b> Select what the controller outputs will do when the user switches control to manual mode.	<b>[OFF]</b> Off, sets output power to 0% (62) <b>[PLS]</b> Bumpless, maintains same output power, if it was less than 75% and stable, otherwise 0% (14) <b>[MAN]</b> Manual Fixed, sets output power to Manual Power setting (33) <b>[USER]</b> User, sets output power to last open-loop set point the user entered (100)	User	Always	<b>Instance 1</b> <i>Map 1</i> <i>Map 2</i> 2182 2662	0x6B (107) 1 0xC (12)	----	uint RWES
<b>[FAiL]</b> [FAiL]	<b>Control Loop (1)</b> <b>Input Error Failure</b> Select what the controller outputs will do when an input error switches control to manual mode.	<b>[OFF]</b> Off, sets output power to 0% (62) <b>[PLS]</b> Bumpless, maintains same output power, if it was less than 75% and stable, otherwise 0% (14) <b>[MAN]</b> Manual Fixed, sets output power to Manual Power setting (33) <b>[USER]</b> User, sets output power to last open-loop set point the user entered (100)	User	Always	<b>Instance 1</b> <i>Map 1</i> <i>Map 2</i> 2184 2664	0x6B (107) 1 0xD (13)	----	uint RWES
<b>[MAN]</b> [MAN]	<b>Control Loop (1)</b> <b>Manual Power</b> Set the manual output power level that will take effect if an input error failure occurs while User Failure Action is set to Manual Fixed.	Set Point Open Loop Limit Low to Set Point Open Loop Limit High (Setup Page)	0.0	Input Error Failure is set to Manual Fixed.	<b>Instance 1</b> <i>Map 1</i> <i>Map 2</i> 2180 2660	0x6B (107) 1 0xB (11)	----	float RWES
<b>[LdE]</b> [L.dE]	<b>Control Loop (1)</b> <b>Open Loop Detect Enable</b> Turn on the open-loop detect feature to monitor a closed-loop operation for the appropriate response.	<b>[no]</b> No (59) <b>[YES]</b> Yes (106)	No	Always	<b>Instance 1</b> <i>Map 1</i> <i>Map 2</i> 1922 2402	0x97 (151) 1 0x16 (22)	74	uint RWES
<b>[Ldt]</b> [L.dt]	<b>Control Loop (1)</b> <b>Open Loop Detect Time</b> The Open Loop Detect Deviation value must occur for this time period to trigger an open-loop error.	0 to 3,600 seconds	240	Open Loop Detect Enable is set to Yes.	<b>Instance 1</b> <i>Map 1</i> <i>Map 2</i> 1924 2404	0x97 (151) 1 0x17 (23)	75	uint RWES
<b>Note:</b> Some values will be rounded off to fit in the four-character display. Full values can be read with other interfaces.  * Available with PM4, PM8 and PM9 models only								R: Read W: Write E: EE-PROM S: User Set

Setup Page

Display	Parameter name Description	Range	Default	Parameter Appears in Menu When	Modbus Rela- tive Address	CIP Class Instance Attribute hex (dec)	Profibus Index	Data Type & Read/ Write
<b>L.dd</b> [ L.dd]	<i>Control Loop (1)</i> <b>Open Loop Detect Deviation</b> Set the value that the process must deviate from the set point to trigger an open-loop error.	-1,999.000 to 9,999.000°F or units -1,110.555 to 5,555.000°C	10.0°F or units 6.0°C	Open Loop Detect En- able is set to Yes.	<b>Instance 1</b> <i>Map 1</i> <i>Map 2</i> 1926 2406	0x97 (151) 1 0x18 (24)	76	float RWES
<b>r.P</b> [ rP]	<i>Control Loop (1)</i> <b>Ramp Action</b> Select when the controller's set point will ramp to the defined end set point.	<b>OFF</b> Off (62) <b>Str</b> Startup (88) <b>SEPt</b> Set Point Change (1647) <b>both</b> Both (13)	Off	Always	<b>Instance 1</b> <i>Map 1</i> <i>Map 2</i> 2186 2666	0x6B (107) 1 0xE (14)	56	uint RWES
<b>r.SC</b> [ r.SC]	<i>Control Loop (1)</i> <b>Ramp Scale</b> Select the scale of the ramp rate.	<b>hour</b> Hours (39) <b>min</b> Minutes (57)	Minutes	Ramp Ac- tion is set to Startup, Set Point or Both.	<b>Instance 1</b> <i>Map 1</i> <i>Map 2</i> 2188 2668	0x6B (107) 1 0xF (15)	57	uint RWES
<b>r.r.t</b> [ r.r.t]	<i>Control Loop (1)</i> <b>Ramp Rate</b> Set the rate for the set point ramp. Set the time units for the rate with the Ramp Scale parameter.	0.0 to 9,999.000°F or units 0.0 to 5,555.000°C	1.0°F or units 1.0°C	Ramp Ac- tion is set to Startup, Set Point or Both.	<b>Instance 1</b> <i>Map 1</i> <i>Map 2</i> 2192 2672	0x6B (107) 1 0x11 (17)	58	float RWES
<b>L.SP</b> [ L.SP]	<i>Control Loop (1)</i> <b>Low Set Point</b> Set the minimum value of the closed loop set point range.	-1,999.000 to 9,999.000°F or units -1,128.000 to 5,537.000°C	-1,999°F or units -1,128°C	Always	<b>Instance 1</b> <i>Map 1</i> <i>Map 2</i> 2164 2644	0x6B (107) 1 to 2 3	52	float RWES
<b>h.SP</b> [ h.SP]	<i>Control Loop (1)</i> <b>High Set Point</b> Set the maximum value of the closed loop set point range..	-1,999.000 to 9,999.000°F or units -1,128.000 to 5,537.000°C	-1,999°F or units -1,128°C	Always	<b>Instance 1</b> <i>Map 1</i> <i>Map 2</i> 2166 2646	0x6B (107) 1 4	53	float RWES
<b>SP.Lo</b> [SP.Lo]	<i>Control Loop (1)</i> <b>Set Point Open Lim- it Low</b> Set the minimum value of the open-loop set point range.	-100 to 100%	-100	Always	<b>Instance 1</b> <i>Map 1</i> <i>Map 2</i> 2168 2649	0x6B (107) 1 5	54	float RWES
<b>SP.hi</b> [SP.hi]	<i>Control Loop (1)</i> <b>Set Point Open Lim- it High</b> Set the maximum value of the open-loop set point range.	-100 to 100%	100	Always	<b>Instance 1</b> <i>Map 1</i> <i>Map 2</i> 2170 2650	0x6B (107) 1 6	55	float RWES
<b>Note:</b> Some values will be rounded off to fit in the four-character display. Full values can be read with other interfaces.  * Available with PM4, PM8 and PM9 models only								R: Read W: Write E: EE- PROM S: User Set

Setup Page

Display	Parameter name Description	Range	Default	Parameter Appears in Menu When	Modbus Relative Address	CIP Class Instance Attribute hex (dec)	Profibus Index	Data Type & Read/Write
<b>oEPE</b> <b>SEt</b> <b>Output Menu</b>								
<b>Fn</b> [ Fn]	<b>Output Digital (1 to 2)</b> <b>Function</b> Select what function will drive this output.	<b>oFF</b> Off (62) <b>EnEb</b> Profile Event Out B (234) <b>EnEA</b> Profile Event Out A (233) <b>CoOL</b> Cool (20) <b>HEAT</b> Heat (36) <b>ALPn</b> Alarm (6)	Output 1 - Heat Output 2 - Alarm Output 3 - Off Output 4 - Off	Always	<b>Instance 1</b> <i>Map 1</i> <i>Map 2</i> 888 1008  Offset to next instance ( <i>Map 1 &amp; Map 2</i> ) equals +30	0x6A (106) 1 to 2 5	83	uint RWES
<b>Fi</b> [ Fi]	<b>Output (1 to 2)</b> <b>Function Instance</b> Set the instance of the function selected above.	1 to 2	1	Always	<b>Instance 1</b> <i>Map 1</i> <i>Map 2</i> 890 1010  Offset to next instance ( <i>Map 1 &amp; Map 2</i> ) equals +30	0x6A (106) 1 to 2 6	84	uint RWES
<b>oCt</b> [ o.Ct]	<b>Output (1 to 2)</b> <b>Control</b> Set the output control type. This parameter is only used with PID control, but can be set anytime.	<b>FtB</b> Fixed Time Base (34) <b>vTb</b> Variable Time Base (103)	Fixed Time Base	Always	<b>Instance 1</b> <i>Map 1</i> <i>Map 2</i> 882 1002  Offset to next instance ( <i>Map 1 &amp; Map 2</i> ) equals +30	0x6A (106) 1 to 4 2	85	uint RWES
<b>oTb</b> [ o.tb]	<b>Output (1 to 2)</b> <b>Time Base</b> Set the time base for fixed-time-base control.	0.1 to 60.0 seconds (solid-state relay or switched dc) 5.0 to 60.0 seconds (mechanical relay or no-arc power control)	0.1 sec. [SSR & sw dc] 20.0 sec. [mech, relay, no-arc]	Control is set to Fixed Time Base.	<b>Instance 1</b> <i>Map 1</i> <i>Map 2</i> 884 1004  Offset to next instance ( <i>Map 1 &amp; Map 2</i> ) equals +30	0x6A (106) 1 to 2 3	86	float RWES
<b>oLo</b> [ o.Lo]	<b>Output (1 to 2)</b> <b>Low Power Scale</b> The power output will never be less than the value specified and will represent the value at which output scaling begins.	0.0 to 100.0%	0.0%	Source is set to PID Heat or Cool.	<b>Instance 1</b> <i>Map 1</i> <i>Map 2</i> 896 1016  Offset to next instance ( <i>Map 1 &amp; Map 2</i> ) equals +30	0x6A (106) 1 to 2 9	87	float RWES
<b>Note:</b> Some values will be rounded off to fit in the four-character display. Full values can be read with other interfaces.  * Available with PM4, PM8 and PM9 models only								R: Read W: Write E: EE-PROM S: User Set

Setup Page

Display	Parameter name Description	Range	Default	Parameter Appears in Menu When	Modbus Relative Address	CIP Class Instance Attribute hex (dec)	Profibus Index	Data Type & Read/ Write
<b>o.h.</b> [ o.hi]	<i>Output (1 to 2)</i> <b>High Power Scale</b> The power output will never be greater than the value specified and will represent the value at which output scaling stops.	0.0 to 100.0%	100.0%	Source is set to PID Heat or Cool.	<b>Instance 1</b> <i>Map 1</i> <i>Map 2</i> 898 1018  Offset to next instance ( <i>Map 1</i> & <i>Map 2</i> ) equals +30	0x6A (106) 1 to 2 0xA (10)	88	float RWES
<b>o.ty</b> [ o.ty]	<i>Output (1 process)</i> <b>Type</b> Select whether the process output will operate in volts or milliamps.	<b>volt</b> Volts (104) <b>mamp</b> Milliamps (112)	Volts	Always if digit 6 of the part number is an "F".	<b>Instance 1</b> <i>Map 1</i> <i>Map 2</i> 720 840	0x76 (118) 1 1	95	uint RWES
<b>Fn</b> [ Fn]	<i>Output Process (1)</i> <b>Function</b> Set the type of function that will drive this output.	<b>off</b> Off (62) <b>dupl</b> Duplex (212) <b>cool</b> Cool (20) <b>heat</b> Heat (36) <b>retr</b> Retransmit (213) <b>entb</b> Profile Event Out B (234) <b>entra</b> Profile Event Out A (233) <b>alarm</b> Alarm (6)	Off	Always if digit 6 of the part number is an "F".	<b>Instance 1</b> <i>Map 1</i> <i>Map 2</i> 722 842	0x76 (118) 1 2	96	uint RWES
<b>r.Sr</b> [ r.Sr]	<i>Output (1 process)</i> <b>Retransmit Source</b> Select the value that will be retransmitted.	<b>ai</b> Analog Input (142) <b>sp</b> Set Point (85) <b>curr</b> Current (22)	Analog Input	Always if digit 6 of the part number is an "F".	<b>Instance 1</b> <i>Map 1</i> <i>Map 2</i> 724 844	0x76 (118) 1 3	97	uint RWES
<b>Fi</b> [ Fi]	<i>Output (1 process)</i> <b>Function Instance</b> Set the instance of the function selected above.	1 to 4	1	Always if digit 6 of the part number is an "F".	<b>Instance 1</b> <i>Map 1</i> <i>Map 2</i> 726 846	0x76 (118) 1 4	98	uint RWES
<b>S.Lo</b> [ S.Lo]	<i>Output (1 process)</i> <b>Scale Low</b> Set the minimum value of the output range.	-100.0 to 100.0	0.00	Always if digit 6 of the part number is an "F".	<b>Instance 1</b> <i>Map 1</i> <i>Map 2</i> 736 856	0x76 (118) 1 9	99	float RWES
<b>S.hi</b> [ S.hi]	<i>Output (1 process)</i> <b>Scale High</b> Set the maximum value of the output range.	-100.0 to 100.0	10.00	Always if digit 6 of the part number is an "F".	<b>Instance 1</b> <i>Map 1</i> <i>Map 2</i> 738 858	0x76 (118) 1 0xA (10)	100	float RWES
<b>Note:</b> Some values will be rounded off to fit in the four-character display. Full values can be read with other interfaces.  * Available with PM4, PM8 and PM9 models only								R: Read W: Write E: EE- PROM S: User Set



Setup Page

Display	Parameter name Description	Range	Default	Parameter Appears in Menu When	Modbus Relative Address	CIP Class Instance Attribute hex (dec)	Profibus Index	Data Type & Read/ Write
<u>r.Lo</u> [ r.Lo]	<i>Output (1 process)</i> <b>Range Low</b> Set the minimum value of the retransmit value range in process units. When the retransmit source is at this value, the retransmit output will be at its Scale Low value.	-1,999.000 to 9,999.000°F or units -1,128.000 to 5,537.000°C	0.0°F or units -18°C	Always if digit 6 of the part number is an "F".	<b>Instance 1</b> <i>Map 1</i> <i>Map 2</i> 740 860	0x76 (118) 1 0xB (11)	101	float RWES
<u>r.hi</u> [ r.hi]	<i>Output (1 process)</i> <b>Range High</b> Set the maximum value of the retransmit value range in process units. When the retransmit source is at this value, the retransmit output will be at its Scale High value.	-1,999.000 to 9,999.000°F or units -1,128.000 to 5,537.000°C	9,999.0°F or units 5,537.0°C	Always if digit 6 of the part number is an "F".	<b>Instance 1</b> <i>Map 1</i> <i>Map 2</i> 742 862	0x76 (118) 1 0xC (12)	102	float RWES
<u>o.CA</u> [ o.CA]	<i>Output (1 process)</i> <b>Calibration Offset</b> Set an offset value for a process output.	-1,999.000 to 9,999.000°F or units -1,110.555 to 5,555.000°C	0.0°F or units 0.0°C	Always if digit 6 of the part number is an "F".	<b>Instance 1</b> <i>Map 1</i> <i>Map 2</i> 732 852	0x76 (118) 1 7	105	float RWES
<u>ALP</u> <u>SET</u> <b>Alarm Menu</b>								
<u>ALY</u> [ A.ty]	<i>Alarm (1 to 4)</i> <b>Type</b> Select whether the alarm trigger is a fixed value or will track the set point.	<u>oFF</u> Off (62) <u>PrAL</u> Process Alarm (76) <u>dEAL</u> Deviation Alarm (24)	Off	Always	<b>Instance 1</b> <i>Map 1</i> <i>Map 2</i> 1508 1908  Offset to next instance ( <i>Map 1</i> & <i>Map 2</i> ) equals +60	0x6D (109) 1 to 4 0xF (15)	20	uint RWES
<u>SrA</u> [ Sr.A]	<i>Alarm (1 to 4)</i> <b>Source Function A</b> Select what will trigger this alarm.	<u>A</u> Analog Input (142) <u>PLU</u> Power, Control Loop (73) <u>PV</u> Process Value (241) <u>Lnr</u> Linearization (238) <u>Cur</u> Current (22)	If Alarm type is set to Deviation or Process.	Type is not set to Off or deviation..	<b>Instance 1</b> <i>Map 1</i> <i>Map 2</i> 1512 1912  Offset to next instance ( <i>Map 1</i> & <i>Map 2</i> ) equals +60	0x6D (109) 1 to 4 0x11 (17)	21	uint RWES
<u>iSA</u> [ iS.A]	<i>Alarm (1 to 2)</i> <b>Source Instance A</b> Set the instance of the function selected above.	1 or 2	1	Type is not set to Off.	<b>Instance 1</b> <i>Map 1</i> <i>Map 2</i> 1514 1914  <b>Instance 2</b> <i>Map 1</i> <i>Map 2</i> 1564 1974	0x6D (109) 1 to 2 0x12 (18)	22	uint RWES
<b>Note:</b> Some values will be rounded off to fit in the four-character display. Full values can be read with other interfaces.  * Available with PM4, PM8 and PM9 models only								<b>R:</b> Read <b>W:</b> Write <b>E:</b> EE-PROM <b>S:</b> User Set

Setup Page

Display	Parameter name Description	Range	Default	Parameter Appears in Menu When	Modbus Rela- tive Address	CIP Class Instance Attribute hex (dec)	Profibus Index	Data Type & Read/ Write
<u>RLH</u> [ A.hy]	<b>Alarm (1 to 4) Hysteresis</b> Set the hysteresis for an alarm. This determines how far into the safe region the process value needs to move before the alarm can be cleared.	0.001 to 9,999.000°F or units 0.001 to 5,555.000°C	1.0°F or units 1.0°C	Type is not set to Off.	<b>Instance 1</b> <i>Map 1</i> <i>Map 2</i> 1484 1884  Offset to next instance ( <i>Map</i> <i>1 equals +50,</i> <i>for Map 2</i> <i>equals +60</i> )	0x6D (109) 1 to 4 3	24	float RWES
<u>RL9</u> [ A.Lg]	<b>Alarm (1 to 4) Logic</b> Select what the output condition will be during the alarm state.	<u>RLC</u> Close On Alarm (17) <u>RLo</u> Open On Alarm (66)	Close On Alarm	Type is not set to Off.	<b>Instance 1</b> <i>Map 1</i> <i>Map 2</i> 1488 1888  Offset to next instance ( <i>Map</i> <i>1 equals +50,</i> <i>for Map 2</i> <i>equals +60</i> )	0x6D (109) 1 to 4 5	25	uint RWES
<u>RSd</u> [ A.Sd]	<b>Alarm (1 to 4) Sides</b> Select which side or sides will trigger this alarm.	<u>both</u> Both (13) <u>h,9h</u> High (37) <u>LoU</u> Low (53)	Both	Type is not set to Off.	<b>Instance 1</b> <i>Map 1</i> <i>Map 2</i> 1486 1886  Offset to next instance ( <i>Map</i> <i>1 equals +50,</i> <i>for Map 2</i> <i>equals +60</i> )	0x6D (109) 1 to 4 4	26	uint RWES
<u>RLA</u> [ A.LA]	<b>Alarm (1 to 4) Latching</b> Turn alarm latching on or off. A latched alarm has to be turned off by the user.	<u>nLAL</u> Non-Latching (60) <u>LAL</u> Latching (49)	Non- Latching	Type is not set to Off.	<b>Instance 1</b> <i>Map 1</i> <i>Map 2</i> 1492 1892  Offset to next instance ( <i>Map</i> <i>1 equals +50,</i> <i>for Map 2</i> <i>equals +60</i> )	0x6D (109) 1 to 4 7	27	uint RWES
<u>RLb</u> [ A.bL]	<b>Alarm (1 to 4) Blocking</b> Select when an alarm will be blocked. After startup and/or after the set point changes, the alarm will be blocked until the process value enters the normal range.	<u>oFF</u> Off (62) <u>StE</u> Startup (88) <u>SEPE</u> Set Point (85) <u>both</u> Both (13)	Off	Type is not set to Off.	<b>Instance 1</b> <i>Map 1</i> <i>Map 2</i> 1494 1894  Offset to next instance ( <i>Map</i> <i>1 equals +50,</i> <i>for Map 2</i> <i>equals +60</i> )	0x6D (109) 1 to 4 8	28	uint RWES
<b>Note:</b> Some values will be rounded off to fit in the four-character display. Full values can be read with other interfaces.  * Available with PM4, PM8 and PM9 models only								R: Read W: Write E: EE- PROM S: User Set

Setup Page

Display	Parameter name Description	Range	Default	Parameter Appears in Menu When	Modbus Relative Address	CIP Class Instance Attribute hex (dec)	Profibus Index	Data Type & Read/ Write
<b>RS</b> [A.Si]	<b>Alarm (1 to 4) Silencing</b> Turn alarm silencing on to allow the user to disable this alarm.	<input type="checkbox"/> <b>oFF</b> Off (62) <input type="checkbox"/> <b>oN</b> On (63)	Off	Type is not set to Off.	<b>Instance 1</b> <i>Map 1</i> <i>Map 2</i> 1490 1890  Offset to next instance ( <i>Map 1 equals +50, for Map 2 equals +60</i> )	0x6D (109) 1 to 4 6	29	uint RWES
<b>RdSP</b> [A.dSP]	<b>Alarm (1 to 4) Display</b> Display an alarm message when an alarm is active.	<input type="checkbox"/> <b>oFF</b> Off (62) <input type="checkbox"/> <b>oN</b> On (63)	On	Type is not set to Off.	<b>Instance 1</b> <i>Map 1</i> <i>Map 2</i> 1510 1910  Offset to next instance ( <i>Map 1 equals +50, for Map 2 equals +60</i> )	0x6D (109) 1 to 4 0x10 (16)	30	uint RWES
<b>RdL</b> [A.dL]	<b>Alarm (1 to 4) Delay</b> Set the span of time that the alarm will be delayed after the process value exceeds the alarm set point.	0 to 9,999 seconds	0	Type is not set to Off.	<b>Instance 1</b> <i>Map 1</i> <i>Map 2</i> 1520 1920  Offset to next instance ( <i>Map 1 equals +50, for Map 2 equals +60</i> )	0x6D (109) 1 to 4 0x15 (21)	31	uint RWES
<p><b>Fun</b> <b>SEt</b> <b>Function Key</b></p>								
<b>LEu</b> [LEv]	<b>Function Key (1 to 2) Level</b> The Function Key will always power up in the low state.  Pressing the Function Key will toggle the selected action.	<input type="checkbox"/> <b>h,9h</b> High (37) <input type="checkbox"/> <b>LoLu</b> Low (53)	High	Always	<b>Instance 1</b> <i>Map 1</i> <i>Map 2</i> 1320 1560 <b>Instance 2</b> <i>Map 1</i> <i>Map 2</i> 1340 1580	0x6E (110) 1 to 2 1	137	uint RWES
<p><b>Note:</b> Some values will be rounded off to fit in the four-character display. Full values can be read with other interfaces.  * Available with PM4, PM8 and PM9 models only</p>								R: Read W: Write E: EE-PROM S: User Set

Setup Page

Display	Parameter name Description	Range	Default	Parameter Appears in Menu When	Modbus Rela- tive Ad- dress	CIP Class Instance Attribute hex (dec)	Profibus Index	Data Type & Read/ Write
<input type="checkbox"/> <b>Fn</b> [ Fn]	<i>Function Key (1 to 2)</i> <b>Digital Input Function</b> Program the EZ Key to trigger an action. Functions respond to a level state change or an edge level change.	<input type="checkbox"/> <b>none</b> None (61) <input type="checkbox"/> <b>PSES</b> Profile Start/Stop, level triggered (208) <input type="checkbox"/> <b>PrOF</b> Profile Start Number, edge triggered (196) <input type="checkbox"/> <b>PhoL</b> Profile Hold/Resume, level triggered (207) <input type="checkbox"/> <b>PdIS</b> Profile Disable, level triggered (206) <input type="checkbox"/> <b>EDR</b> TRU-TUNE+® Dis-able, level triggered (219) <input type="checkbox"/> <b>oFF</b> Control Outputs Off, level triggered (90) <input type="checkbox"/> <b>MAN</b> Manual/Auto Mode, level triggered (54) <input type="checkbox"/> <b>tUnE</b> Tune, edge triggered (98) <input type="checkbox"/> <b>idLE</b> Idle Set Point En-able, level triggered (107) <input type="checkbox"/> <b>FRL</b> Force Alarm, level triggered (218) <input type="checkbox"/> <b>RoF</b> Alarm Outputs & Control Loop Off, level triggered (220) <input type="checkbox"/> <b>SIL</b> Silence Alarms, edge triggered (108) <input type="checkbox"/> <b>RLR</b> Alarm Reset, edge triggered (6) <input type="checkbox"/> <b>PLoC</b> Lock Keypad, level triggered (217) <input type="checkbox"/> <b>uSrr</b> Restore User Set-tings, edge triggered (227)	None	Always	<b>Instance 1</b> <i>Map 1 Map 2</i> 1324 1564 <b>Instance 2</b> <i>Map 1 Map 2</i> 1344 1584	0x6E (110) 1 to 2 3	138	uint RWES
<input type="checkbox"/> <b>F<sub>i</sub></b> [ Fi]	<i>Function Key (1 to 2)</i> <b>Instance</b> Select which instance the EZ Key will affect. If only one instance is available, any selection will affect it.	0 to 4	0	Always	<b>Instance 1</b> <i>Map 1 Map 2</i> 1326 1566 <b>Instance 2</b> <i>Map 1 Map 2</i> 1346 1586	0x96 (110) 1 to 2 4	139	uint RWES
<input type="checkbox"/> <b>9LbL</b> <input type="checkbox"/> <b>SEE</b> <b>Global Menu</b>								
<input type="checkbox"/> <b>C<sub>F</sub></b> [ C <sub>F</sub> ]	<i>Global</i> <b>Display Units</b> Select which scale to use for temperature.	<input type="checkbox"/> <b>F</b> °F (30) <input type="checkbox"/> <b>C</b> °C (15)	°F	Always	<b>Instance 1</b> <i>Map 1 Map 2</i> 1838 2308	0x67 (103) 1 5	110	uint RWES
<input type="checkbox"/> <b>AC<sub>LF</sub></b> [AC.LF]	<i>Global</i> <b>AC Line Frequency</b> Set the frequency to the applied ac line power source.	<input type="checkbox"/> <b>50</b> 50 Hz (3) <input type="checkbox"/> <b>60</b> 60 Hz (4)	60 Hz	Always	<b>Instance 1</b> <i>Map 1 Map 2</i> 886 1006	0x6A (106) 1 4	89	uint RWES
<b>Note:</b> Some values will be rounded off to fit in the four-character display. Full values can be read with other interfaces.  * Available with PM4, PM8 and PM9 models only								R: Read W: Write E: EE- PROM S: User Set

Setup Page

Display	Parameter name Description	Range	Default	Parameter Appears in Menu When	Modbus Relative Address	CIP Class Instance Attribute hex (dec)	Profibus Index	Data Type & Read/Write
<b>[R.tYP]</b> [R.tyP]	<i>Profile</i> <b>Ramping Type</b>	<b>[RAtE]</b> Rate (81) <b>[t]</b> Time (143)	Time	Always	<b>Instance 1</b> <i>Map 1</i> <i>Map 2</i> ---- 4414	0x7A (122) 1 26 (38)	----	uint RWE
<b>[P.tYP]</b> [P.tyP]	<i>Profile</i> <b>Profile Type</b> Set the profile startup to be based on a set point or a process value.	<b>[SEtP]</b> Set Point (85) <b>[Pro]</b> Process (75)	Set Point	Always	<b>Instance 1</b> <i>Map 1</i> <i>Map 2</i> 2534 4354	0x7A (122) 1 8	----	uint RWE
<b>[gSE]</b> [gSE]	<i>Profile</i> <b>Guaranteed Soak Enable</b> Enables the guaranteed soak deviation function in profiles.	<b>[oFF]</b> Off (62) <b>[on]</b> On (63)	Off	Always	<b>Instance 1</b> <i>Map 1</i> <i>Map 2</i> 2530 4350	0x7A (122) 1 6	----	uint RWE
<b>[gSd1]</b> [gSd1]	<i>Profile</i> <b>Guaranteed Soak Deviation 1</b> Set the value of the deviation band that will be used in all profile step types. The process value must enter the deviation band before the step can proceed.	0.0 to 9,999.000°F or units 0.0 to 5,555.000°C	10.0°F or units 6.0°C	Always	<b>Instance 1</b> <i>Map 1</i> <i>Map 2</i> 2532 4352	0x7A (122) 1 7	----	float RWE
<b>[Si.a]</b> [Si.a]	<i>Profile Event Input</i> <b>Source Instance A</b> Set the source for WE1..	5 to 6	1	Function is set to Compressor.	<b>Instance 1</b> <i>Map 1</i> <i>Map 2</i> ---- 4390	0x7A (122) 1 0x1A (26)	----	uint RWES
<b>[Si.b]</b> [Si.b]	<i>Profile Event Input</i> <b>Source Instance B</b> Set the source for WE2..	5 to 6	1	Function is set to Compressor.	<b>Instance 1</b> <i>Map 1</i> <i>Map 2</i> ---- 4392	7A (122) 1 0x1B (27)	----	uint RWES
<b>[Poti]</b> [Poti]	<i>Global Menu</i> <b>Power Out Time</b> If profile is running and power is lost, profile will resume where it left off provided time set has not expired prior to power restoration.	0 to 9999 seconds	0	If 4th digit in controller part number is a B or an E.	<b>Instance 1</b> <i>Map 1</i> <i>Map 2</i> ---- 4484	7A (122) 1 0x49 (73)	----	uint RWE
<b>[C.LEd]</b> [C.LEd]	<i>Global Menu</i> <b>Communications LED Action</b> Turns comms LED on or off for selected comms ports.	<b>[Con1]</b> Comm port 2 (1189) <b>[Con2]</b> Comm port 1 (1190) <b>[both]</b> Comm port 1 and 2 (13) <b>[oFF]</b> Off (62)	both	Always	<b>Instance 1</b> <i>Map 1</i> <i>Map 2</i> 1856 2326	0x6A (103) 1 0x0E (14)	----	uint RWES
<b>[Zone]</b> [Zone]	<i>Global Menu</i> <b>Zone</b> Turns Zone LED on or off based on selection.	<b>[oFF]</b> Off (62) <b>[on]</b> On (63)	On	Always	<b>Instance 1</b> <i>Map 1</i> <i>Map 2</i> ---- 2350	0x6A (103) 1 0x1A (26)	----	uint RWES
<b>Note:</b> Some values will be rounded off to fit in the four-character display. Full values can be read with other interfaces.  * Available with PM4, PM8 and PM9 models only								<b>R:</b> Read <b>W:</b> Write <b>E:</b> EE-PROM <b>S:</b> User Set

Setup Page

Display	Parameter name Description	Range	Default	Parameter Appears in Menu When	Modbus Rela- tive Address	CIP Class Instance Attribute hex (dec)	Profibus Index	Data Type & Read/ Write
<b>[ChRn]</b> [Chan]	<i>Global Menu</i> <b>Channel</b> Turns Channel LED on or off based on se- lection.	<b>oFF</b> Off (62) <b>oN</b> On (63)	On	Always	<b>Instance 1</b> <i>Map 1</i> <i>Map 2</i> ---- 2352	0x6A (103) 1 0x1B (27)	----	uint RWES
<b>[dPrS]</b> [dPrS]	<i>Global Menu</i> <b>Display Pairs</b> Defines the number of Display Pairs.	1 to 10	2	Always	<b>Instance 1</b> <i>Map 1</i> <i>Map 2</i> ---- 2354	0x6A (103) 1 0x1C (28)	----	uint RWES
<b>[dEt]</b> [d.ti]	<i>Global Menu</i> <b>Display Time</b> Time delay in toggling between channel 1 and channel 2.	0 to 60	0	Always	<b>Instance 1</b> <i>Map 1</i> <i>Map 2</i> ---- 2356	0x6A (103) 1 0x1D (29)	----	uint RWES
<b>[USrS]</b> [USr.S]	<i>Global Menu</i> <b>User Settings Save</b> Save all of this contr- oller's settings to the selected set.	<b>SEt1</b> User Set 1 (101) <b>SEt2</b> User Set 2 (102) <b>nonE</b> None (61)	None	Always	<b>Instance 1</b> <i>Map 1</i> <i>Map 2</i> 26 26	0x(101) 1 0xE (14)	118	uint RWE
<b>[USrR]</b> [USr.r]	<i>Global Menu</i> <b>User Restore Set- tings</b> Replace all of this controller's settings with another set.	<b>FctY</b> Factory (31) <b>nonE</b> None (61) <b>SEt1</b> User Set 1 (101) <b>SEt2</b> User Set 2 (102)	None		<b>Instance 1</b> <i>Map 1</i> <i>Map 2</i> 24 24	0x65 (101) 1 0xD (13)	117	uint RWE
<b>[CoM]</b> <b>[SEt]</b> <b>Communications Menu</b>								
<b>[PCoL]</b> [PCoL]	<i>Communications 1</i> <b>Protocol</b> Set the protocol of this controller to the proto- col that this network is using.	<b>Std</b> Standard Bus (1286) <b>Mod</b> Modbus RTU (1057)	Modbus	Always if digit 8 is a "1".	<b>Instance 1</b> <i>Map 1</i> <i>Map 2</i> 2492 2972	0x96 (150) 1 7	----	uint RWE
<b>[AdS]</b> [Ad.S]	<i>Communications 1</i> <b>Address Standard Bus</b> Set the network ad- dress of this control- ler. Each device on the network must have a unique address. The Zone Display on the front panel will display this number.	1 to 16	1	Protocol is set to Standard- bus.	<b>Instance 1</b> <i>Map 1</i> <i>Map 2</i> 2480 2960	0x96 (150) 1 1	----	uint RWE
<b>[AdM]</b> [Ad.M]	<i>Communications (1)</i> <b>Address Modbus</b> Set the network ad- dress of this control- ler. Each device on the network must have a unique address.	1 to 247	1	Protocol is set to Modbus.	<b>Instance 1</b> <i>Map 1</i> <i>Map 2</i> 2482 2962	0x96 (150) 1 2	----	uint RWE
<b>Note:</b> Some values will be rounded off to fit in the four-character display. Full values can be read with other interfaces.  * Available with PM4, PM8 and PM9 models only								R: Read W: Write E: EE- PROM S: User Set

Setup Page

Display	Parameter name Description	Range	Default	Parameter Appears in Menu When	Modbus Relative Address	CIP Class Instance Attribute hex (dec)	Profibus Index	Data Type & Read/ Write
<b>bRd</b> [bAUd]	<i>Communications (1)</i> <b>Baud Rate Modbus</b> Set the speed of this controller's communications to match the speed of the serial network.	9,600 (188) 19,200 (189) 38,400 (190)	9,600	Protocol is set to Modbus.	<b>Instance 1</b> <i>Map 1</i> <i>Map 2</i> 2484 2964	0x96 (150) 1 3	----	uint RWE
<b>PRr</b> [ PAr]	<i>Communications</i> <b>Parity Modbus (1)</b> Set the parity of this controller to match the parity of the serial network.	<b>none</b> None (61) <b>Even</b> Even (191) <b>odd</b> Odd (192)	None	Protocol is set to Modbus.	<b>Instance 1</b> <i>Map 1</i> <i>Map 2</i> 2486 2966	0x96 (150) 1 4	----	uint RWE
<b>PHL</b> [M.hL]	<i>Communications (1)</i> <b>Modbus Word Order</b> Select the word order of the two 16-bit words in the floating-point values.	<b>LoHi</b> Low-High (1331) <b>HiLo</b> High-Low (1330)	Low-High	Protocol is set to Modbus.	<b>Instance 1</b> <i>Map 1</i> <i>Map 2</i> 2488 2968	0x96 (150) 1 5	----	uint RWE
<b>PMAP</b> [ Map]	<i>Communications (1)</i> <b>Data Map</b> If set to 1 the control will use PM legacy mapping. If set to 2 the control will use new mapping to accommodate new functions.	1 to 2	1 if 9th digit of part number is a 1 otherwise, 2.	Always	----	----	----	----
<b>nVS</b> [ nV.S]	<i>Communications (1)</i> <b>Non-volatile Save</b> If set to Yes all values written to the control will be saved in EE-PROM.	<b>YES</b> Yes (106) <b>no</b> No (59)	Yes	Always	<b>Instance 1</b> <i>Map 1</i> <i>Map 2</i> 2494 2974	0x96 (150) 1 8	198	uint RWE
<b>REt</b> * <b>SEE</b> <b>Real Time Clock Menu</b>								
<b>hOUR</b> [hoUr]	<i>Real Time Clock</i> <b>Hours</b>	0 to 23	0	Always if 4th digit in part number is a "B" or "E".	<b>Instance 1</b> <i>Map 1</i> <i>Map 2</i> ---- 4004	88 (136) 1 3	----	uint RW
<b>PMin</b> [Min]	<i>Real Time Clock</i> <b>Minutes</b>	0 to 59	0	Always if 4th digit in part number is a "B" or "E".	<b>Instance 1</b> <i>Map 1</i> <i>Map 2</i> ---- 4006	88 (136) 1 4	----	uint RW
<b>Note:</b> Some values will be rounded off to fit in the four-character display. Full values can be read with other interfaces.  * Available with PM4, PM8 and PM9 models only								<b>R:</b> Read <b>W:</b> Write <b>E:</b> EE-PROM <b>S:</b> User Set



Setup Page

Display	Parameter name Description	Range	Default	Parameter Appears in Menu When	Modbus Rela- tive Address	CIP Class Instance Attribute hex (dec)	Profibus Index	Data Type & Read/ Write
<b>doW</b> [doW]	<i>Real Time Clock</i> <b>Day of Week</b>	<input type="checkbox"/> <b>Sun</b> Sunday (1565) <input checked="" type="checkbox"/> <b>Mon</b> Monday (1559) <input type="checkbox"/> <b>Tue</b> Tuesday (1560) <input type="checkbox"/> <b>Wed</b> Wednesday (1561) <input type="checkbox"/> <b>Thu</b> Thursday (1562) <input type="checkbox"/> <b>Fri</b> Friday (1563) <input type="checkbox"/> <b>Sat</b> Saturday (1564)	Sun	Always if 4th digit in part number is a "B" or "E".	<b>Instance 1</b> <i>Map 1</i> <i>Map 2</i> ----    4002	88 (136) 1 2	----	uint RW
<b>Note:</b> Some values will be rounded off to fit in the four-character display. Full values can be read with other interfaces.  * Available with PM4, PM8 and PM9 models only								R: Read W: Write E: EE- PROM S: User Set

# 7



## Chapter 7: Profiling Page









### Navigating the Profiling Page

**Note:**

Some of these menus and parameters may not appear, depending on the controller's options. See model number information in the Appendix for more information. If there is only one instance of a menu, no submenus will appear.

The Profiling Page allows you to enter your ramp and soak profile information.

To go to the Profiling Page from the Home Page, press the Advance Key  for three seconds, until **PROF** appears in the lower display and the profile number appears in the upper display. Press the Up  or Down  key to change to another profile.

- Press the Advance Key  to move to the selected profile's first step.
- Press the Up  or Down  keys to move through the steps.
- Press the Advance Key  to move through the selected step's settings.
- Press the Up  or Down  keys to change the step's settings.
- Press the Infinity Key  at any time to return to the step number prompt.
- Press the Infinity Key  again to return to the profile number prompt.
- From any point press and hold the Infinity Key  for two seconds to return to the Home Page.

**Note:**

Changes made to profile parameters in the Profiling Pages will be saved and will also have an immediate impact on the running profile. Some parameters in the Profile Status Menu can be changed for the currently running profile, but should only be changed by knowledgeable personnel and with caution. Changing parameters via the Profile Status Menu will not change the stored profile but will have an immediate impact on the profile that is running.

### Profiling Parameters

**PI** to **P4**

**PROF**

**1** to **10**

**PI**

**STEP** Step Type

**ESP1** Target Set Point Loop 1

**hour** Hours

**min** Minutes

**SEC** Seconds





**RATE** Rate

**WDPI** Wait For Process 1

**WDE1** Wait For Event 1

### How to Start a Profile

After defining the profile follow the steps below to run the profile:

1. From the Home Page push the Advance Key  repeatedly until Profile Start **PST1** appears in the lower display.
2. Use the Up  or Down  key to choose the file or step number within a profile where you want the profile to begin running.
3. Press the Advance Key . This takes you to Profile Action **PACT1**, where you can select the appropriate action.
  - **none** No action
  - **PROF** Begin execution from first step of the specified profile number, whether it exists or not.
  - **PAUS** Pause the currently running profile.
  - **RESU** Resume running the profile from the previously paused step.
  - **End** End the profile.
  - **STEP** Begin running the profile from the specified step number.

**Note:**

Avoid continuous writes within loops. Excessive writes to EEPROM will cause premature EEPROM failure. The EEPROM is rated for 1,000,000 writes. (To disable EEPROM writes, go to the Setup Page and then the **CONF** menu. Proceed to the **WUS** prompt and set it to no for **CONF** 1, 2 or both.)

**WDE2** Wait for Event 2

**dobd** Day of Week

**JS** Jump Step

**JC** Jump Count

**End** End Type

**Ent1** Event 1

**Ent2** Event 2

Profiling Page

Display	Parameter name Description	Range	Default	Parameter Appears in Menu When	Modbus Relative Ad- dress	CIP Class Instance Attribute hex (dec)	Data Type & Read/ Write
<div style="border: 1px solid black; padding: 2px;"> <span style="border: 1px solid black; padding: 1px;">P1</span>  <span style="border: 1px solid black; padding: 1px;">Prof</span>  <b>Profiling Menu</b> </div>							
<div style="border: 1px solid black; padding: 2px;"> <span style="border: 1px solid black; padding: 1px;">P1</span>                      [ P1] to  <span style="border: 1px solid black; padding: 1px;">P4</span>                      [ P4]                 </div>	<b>Step</b> Select a step to edit or view.	1 to 10 [profile 1] 11 to 20 [profile 2] 21 to 30 [profile 3] 31 to 40 [profile 4]	----	Always	----	----	----
<div style="border: 1px solid black; padding: 2px;"> <span style="border: 1px solid black; padding: 1px;">SEYP</span>                      [S.typ]                 </div>	<b>Step Type</b> Select a step type. <b>Note:</b> When configuring the profile type there will be a Time prompt as delivered from the factory (default). If rate is desired navigate to the Setup Page and then the Global Menu where Ramping Type can be changed.	<span style="border: 1px solid black; padding: 1px;">USEP</span> Unused Step (50) <span style="border: 1px solid black; padding: 1px;">END</span> End (27) <span style="border: 1px solid black; padding: 1px;">JL</span> Jump Loop (116) <span style="border: 1px solid black; padding: 1px;">LTC</span> Wait For Time (1543) <span style="border: 1px solid black; padding: 1px;">LUBO</span> Wait For Both (210) <span style="border: 1px solid black; padding: 1px;">LUPR</span> Wait For Process (209) <span style="border: 1px solid black; padding: 1px;">LUE</span> Wait For Event (144) <span style="border: 1px solid black; padding: 1px;">SOAK</span> Soak (87) <span style="border: 1px solid black; padding: 1px;">T</span> Time (143) <span style="border: 1px solid black; padding: 1px;">RATE</span> Rate (81)	Unused	Always	<b>Instance 1</b> Map 1    Map 2 2570    4500  Offset to next instance (Map 1 equals +50, Map 2 equals +100)	0x79 (121) 1 to 40 1	uint RWE
<div style="border: 1px solid black; padding: 2px;"> <span style="border: 1px solid black; padding: 1px;">t.SP1</span>                      [t.SP1]                 </div>	<i>Step Type Parameters</i> <b>Target Set Point</b> (loop 1) Select the set point for this step.	-1,999.000 to 9,999.000°F or units -1,128 to 5,537.000°C	0.0°F or units -18°C	Step Type is set to Time, Rate, Wait for Process or Wait for Both.	<b>Instance 1</b> Map 1    Map 2 2572    4502  Offset to next instance (Map 1 equals +50, Map 2 equals +100)	0x79 (121) 1 to 40 2	float RWE
<div style="border: 1px solid black; padding: 2px;"> <span style="border: 1px solid black; padding: 1px;">hoUr</span>                      [hoUr]                 </div>	<i>Step Type Parameters</i> <b>Hours</b> Select the hours (plus Minutes and Seconds) for a timed step.	0 to 99	0	Step Type is set to Time or Soak.	<b>Instance 1</b> Map 1    Map 2 2574    4504  Offset to next instance (Map 1 equals +50, Map 2 equals +100)	0x79 (121) 1 to 40 3	uint RWE
<div style="border: 1px solid black; padding: 2px;"> <span style="border: 1px solid black; padding: 1px;">Min</span>                      [Min]                 </div>	<i>Step Type Parameters</i> <b>Minutes</b> Select the minutes (plus Hours and Seconds) for a timed step.	0 to 59	0	Step Type is set to Time or Soak.	<b>Instance 1</b> Map 1    Map 2 2576    4506  Offset to next instance (Map 1 equals +50, Map 2 equals +100)	0x79 (121) 1 to 40 4	uint RWE
<b>Note:</b> Some values will be rounded off to fit in the four-character display. Full values can be read with other interfaces.							R: Read W: Write E: EEPROM S: User Set

Profiling Page

Display	Parameter name Description	Range	Default	Parameter Appears in Menu When	Modbus Relative Ad- dress	CIP Class Instance Attribute hex (dec)	Data Type & Read/ Write
<b>SEC</b> [ SEC]	<i>Step Type Parameters</i> <b>Seconds</b> Select the seconds (plus Hours and Minutes) for a timed step.	0 to 59	0	Step Type is set to Time or Soak.	<b>Instance 1</b> <i>Map 1</i> <i>Map 2</i> 2578   4508  Offset to next instance ( <i>Map 1 equals +50, Map 2 equals +100</i> )	0x79 (121) 1 to 40 5	uint RWE
<b>W.P1</b> [W.P1]	<i>Step Type Parameters</i> <b>Wait For Process Value</b> Select which analog input Wait For Process will use.	-1,999.000 to 9,999.000°F or units -1,128.000 to 5,537.000°C	0.0°F or units -18.0°C	Step Type is set to Wait For Process.	<b>Instance 1</b> <i>Map 1</i> <i>Map 2</i> 2590   4520  Offset to next instance ( <i>Map 1 equals +50, Map 2 equals +100</i> )	0x79 (121) 1 to 40 0xB (11)	float RWE
<b>WE.1</b> [WE.1]	<i>Step Type Parameters</i> <b>Wait Event (5-6)</b> Select the event state that must be satisfied during this step. Digital input 5 provides the state of Event 1, and digital input 6 provides the state of Event 2.	<input type="radio"/> <b>OFF</b> Off (62) <input type="radio"/> <b>ON</b> On (63) <input type="radio"/> <b>NONE</b> None (61)	Off	Step Type is set to Wait Event or Wait for Both.	<b>Instance 1</b> <i>Map 1</i> <i>Map 2</i> 2586   4516  Offset to next instance ( <i>Map 1 equals +50, Map 2 equals +100</i> )	0x79 (121) 1 to 40 9	uint RWE
<b>WE.2</b> [WE.2]	<i>Step Type Parameters</i> <b>Wait Event (5-6)</b> Select the event state that must be satisfied during this step. Digital input 5 provides the state of Event 1, and digital input 6 provides the state of Event 2.	<input type="radio"/> <b>OFF</b> Off (62) <input type="radio"/> <b>ON</b> On (63) <input type="radio"/> <b>NONE</b> None (61)	Off	Step Type is set to Wait Event or Wait for Both.	<b>Instance 1</b> <i>Map 1</i> <i>Map 2</i> 2588   4518  Offset to next instance ( <i>Map 1 equals +50, Map 2 equals +100</i> )	0x79 (121) 1 to 40 0xA (10)	uint RWE
<b>dow</b> [dow]	<i>Step Type Parameters</i> <b>Day of Week</b>	<input type="radio"/> <b>Ed</b> Every Day (1567) <input type="radio"/> <b>LUd</b> Week days (1566) <input type="radio"/> <b>Sun</b> Sunday (1565) <input type="radio"/> <b>Moan</b> Monday (1559) <input type="radio"/> <b>TuE</b> Tuesday (1560) <input type="radio"/> <b>WJEd</b> Wednesday (1561) <input type="radio"/> <b>ThUr</b> Thursday (1562) <input type="radio"/> <b>Fr</b> Friday (1563) <input type="radio"/> <b>SAT</b> Saturday (1564)	Sunday	If real time clock is present and StepType is set to Wait for Time.	<b>Instance 1</b> <i>Map 1</i> <i>Map 2</i> - - - -   4580  Offset to next instance <i>Map 2</i> equals +100)	0x79 (121) 1 to 40 0x29 (41)	uint RWE
<b>JS</b> [ JS]	<i>Step Type Parameters</i> <b>Jump Step</b> Select a step to jump to.	1 to 40	0	Step Type is set to Jump Loop.	<b>Instance 1</b> <i>Map 1</i> <i>Map 2</i> 2592   4522  Offset to next instance ( <i>Map 1 equals +50, Map 2 equals +100</i> )	0x79 (121) 1 to 40 0xC (12)	uint RWE
<b>Note:</b> Some values will be rounded off to fit in the four-character display. Full values can be read with other interfaces.							<b>R:</b> Read <b>W:</b> Write <b>E:</b> EEPROM <b>S:</b> User Set



Profiling Page

Display	Parameter name Description	Range	Default	Parameter Appears in Menu When	Modbus Relative Ad- dress	CIP Class Instance Attribute hex (dec)	Data Type & Read/ Write
<input type="checkbox"/> <b>JC</b> [ JC]	<i>Step Type Parameters</i> <b>Jump Count</b> Set the number of jumps. A value of 0 creates an infinite loop. Loops can be nested four deep.	0 to 9,999	0	Step Type is set to Jump Loop.	<b>Instance 1</b> <i>Map 1</i> <i>Map 2</i> 2594    4524  Offset to next instance ( <i>Map 1 equals +50, Map 2 equals +100</i> )	0x79 (121) 1 to 40 0xD (13)	uint RWE
<input type="checkbox"/> <b>End</b> [ End]	<i>Step Type Parameters</i> <b>End Type</b> Select what the controller will do when this profile ends.	<input type="checkbox"/> <b>OFF</b> Control Mode set to Off (62) <input type="checkbox"/> <b>Hold</b> Hold last closed-loop set point in the profile (47) <input type="checkbox"/> <b>USER</b> User, reverts to previous set point (100)	Off	Step Type is set to End.	<b>Instance 1</b> <i>Map 1</i> <i>Map 2</i> 2596    4526  Offset to next instance ( <i>Map 1 equals +50, Map 2 equals +100</i> )	0x79 (121) 1 to 40 0xE (14)	uint RWE
<input type="checkbox"/> <b>Ent1</b> [Ent1]	<i>Step Type Parameters</i> <b>Profile Event Output (A)</b> Select whether Event Output 1 or 2 is on or off during this step.	<input type="checkbox"/> <b>OFF</b> Off (62) <input type="checkbox"/> <b>on</b> On (63)	Off	Step Type is set to Time, Rate, Soak, Wait Event, Wait for Process, Wait for Both or Jump Loop.	<b>Instance 1</b> <i>Map 1</i> <i>Map 2</i> 2582    4512  Offset to next instance ( <i>Map 1 equals +50, Map 2 equals +100</i> )	0x79 (121) 1 to 40 7	uint RWE
<input type="checkbox"/> <b>Ent2</b> [Ent2]	<i>Step Type Parameters</i> <b>Profile Event Output (B)</b> Select whether Event Output 1 or 2 is on or off during this step.	<input type="checkbox"/> <b>OFF</b> Off (62) <input type="checkbox"/> <b>on</b> On (63)	Off	Step Type is set to Time, Rate, Soak, Wait Event, Wait for Process, Wait for Both or Jump Loop.	<b>Instance 1</b> <i>Map 1</i> <i>Map 2</i> 2584    4514  Offset to next instance ( <i>Map 1 equals +50, Map 2 equals +100</i> )	0x79 (121) 1 to 40 8	uint RWE
<b>Note:</b> Some values will be rounded off to fit in the four-character display. Full values can be read with other interfaces.							R: Read W: Write E: EEPROM S: User Set



# 8

## Chapter 8: Factory Page

### Navigating the Factory Page

To go to the Factory Page from the Home Page, press and hold both the Advance  and Infinity  keys for six seconds.

- Press the Advance Key  to move through the parameter prompts.

- Press the Up  or Down  keys to change the parameter value.
- Press the Infinity Key  to return to the Home Page.

Note:

Some of these menus and parameters may not appear, depending on the controller's options. See model number information in the Appendix for more information. If there is only one instance of a menu, no submenus will appear.

```
[USE]
[FCEY] Custom Setup Menu
  [ ] 1 to [ ] 20
  [USE] Custom Setup
  [PRP] Parameter
  [ ] ,id Instance ID

[LoC]
[FCEY] Security Setting Menu
  [LoC] Security Setting
    [LoCo] Operations Page
    [LoCP] Profiling Page
    [PRSE] Password Enable
    [rLoC] Read Lock
    [SLoC] Write Security
    [LoCL] Locked Access Level
    [roLL] Rolling Password
    [PRSw] User Password
    [PRSA] Administrator Password

[ULoC]
[FCEY] Security Setting Menu
  [CodE] Public Key
  [PRSS] Password

[d ,R9]
[FCEY] Diagnostics Menu
  [d ,R9] Diagnostics
    [ ] Pn Part Number
    [ ] rEu Software Revision
    [ ] SbLd Software Build Number
    [ ] Sn Serial Number
    [ ] dRtE Date of Manufacture

[CAL]
[FCEY] Calibration Menu
  [ ] 1 to [ ] 2
  [CAL] Calibration
    [ ] P7u Electrical Measurement
    [EL ,o] Electrical Input Offset
    [EL ,S] Electrical Input Slope
    [EL ,o] Electrical Output Offset
    [EL ,S] Electrical Output Slope
```

Factory Page

Display	Parameter name Description	Range	Default	Parameter Appears in Menu When	Modbus Relative Address	CIP Class Instance Attribute hex (dec)	Profibus Index	Data Type & Read/Write
<p><b>Custom Menu</b></p>								
<p><b>PAR</b> [Par]</p>	<p><i>Custom Menu</i> <b>Parameter 1 to 20</b> Select the parameters that will appear in the Home Page.</p> <p>The Parameter 1 value will appear in the upper display of the Home Page. It cannot be changed with the Up and Down Keys in the Home Page.</p> <p>The Parameter 2 value will appear in the lower display in the Home Page. It can be changed with the Up and Down Keys, if the parameter is a writable one.</p> <p>Scroll through the other Home Page parameters with the Advance Key  .</p>	<p><b>none</b> None</p> <p><b>gsd1</b> Guaranteed Soak Deviation 1 Value</p> <p><b>PARr</b> Profile Action Request</p> <p><b>PSEr</b> Profile Start</p> <p><b>idle</b> Idle Set Point</p> <p><b>ttun</b> TRU-TUNE+® Enable</p> <p><b>rre</b> Ramp Rate</p> <p><b>chy</b> Cool Hysteresis</p> <p><b>CPb</b> Cool Proportional Band</p> <p><b>hhY</b> Heat Hysteresis</p> <p><b>hpb</b> Heat Proportional Band</p> <p><b>db</b> Dead Band</p> <p><b>td</b> Time Derivative</p> <p><b>ti</b> Time Integral</p> <p><b>CPr</b> Cool Power</p> <p><b>hPr</b> Heat Power</p> <p><b>CPM</b> User Control Mode</p> <p><b>AUE</b> Autotune</p> <p><b>oP</b> Open Loop Set Point</p> <p><b>ACSP</b> Active Set Point</p> <p><b>ACPv</b> Active Process Value</p> <p><b>SEPE</b> Set Point</p> <p><b>CUSE</b> Custom Menu</p> <p><b>AhY</b> Alarm Hysteresis</p> <p><b>AhH</b> Alarm High Set Point</p> <p><b>ALo</b> Alarm Low Set Point</p> <p><b>USRr</b> User Restore Set</p> <p><b>C_F</b> Display Units</p> <p><b>CA</b> Input Calibration Offset</p> <p><b>Pro</b> Process</p>	<p>See: Home Page</p>	<p>Always</p>	<p>----</p>	<p>----</p>	<p>----</p>	<p>----</p>
<p><b>iid</b> [iid]</p>	<p><i>Custom Setup (1 to 20)</i> <b>Instance ID</b> Select which instance of the parameter will be selected.</p>	<p>1 to 4</p>	<p>----</p>	<p>If there is only one valid instance for corresponding class member then not active, otherwise active.</p>	<p>----</p>	<p>----</p>	<p>----</p>	<p>----</p>
<p><b>Note:</b> Some values will be rounded off to fit in the four-character display. Full values can be read with other interfaces.</p> <p><b>If there is only one instance of a menu, no submenus will appear.</b></p>								<p>R: Read W: Write E: EEPROM S: User Set</p>



### Factory Page

Display	Parameter name Description	Range	Default	Parameter Appears in Menu When	Modbus Relative Ad- dress	CIP Class Instance Attribute hex (dec)	Profibus Index	Data Type & Read/ Write
<div style="border: 1px solid black; padding: 2px;"> <span style="border: 1px solid black; padding: 1px;">LoC</span>  <span style="border: 1px solid black; padding: 1px;">FLY</span>  <b>Security Setting Menu</b> </div>								
<span style="border: 1px solid black; padding: 1px;">LoCo</span> [LoC.o]	<i>Security Setting</i> <b>Operations Page</b> Change the security level of the Operations Page.	1 to 3	2	Always	----	----	----	----
<span style="border: 1px solid black; padding: 1px;">LoCP</span> [LoC.P]	<i>Security Setting</i> <b>Profiling Page</b> Change the security level of the Profiling Page.	1 to 3	3	Always	----	----	----	----
<span style="border: 1px solid black; padding: 1px;">PSE</span> [LoC.P]	<i>Security Setting</i> <b>Password Enable</b> Turn security features on or off.	<input type="checkbox"/> <b>oFF</b> Off <input type="checkbox"/> <b>on</b> On	Off	Always	----	----	----	----
<span style="border: 1px solid black; padding: 1px;">rLoC</span> [rLoC]	<i>Security Setting</i> <b>Read Lock</b> Set the read security clearance level. The user can access the selected level and all lower levels. If the Set Lockout Security level is higher than the Read Lockout Security, the Read Lockout Security level takes priority.	1 to 5	5	Always	----	----	----	----
<span style="border: 1px solid black; padding: 1px;">SLoC</span> [SLoC]	<i>Security Setting</i> <b>Write Security</b> Set the write security clearance level. The user can access the selected level and all lower levels. If the Set Lockout Security level is higher than the Read Lockout Security, the Read Lockout Security level takes priority.	0 to 5	5	Always	----	----	----	----
<span style="border: 1px solid black; padding: 1px;">LoCL</span> [LoC.L]	<i>Security Setting</i> <b>Locked Access Level</b> Determines user level menu visibility when security is enabled. See Features section under Password Security.	1 to 5	5	Always	----	----	----	----
<b>Note:</b> Some values will be rounded off to fit in the four-character display. Full values can be read with other interfaces.  <b>If there is only one instance of a menu, no submenus will appear.</b>								<b>R:</b> Read <b>W:</b> Write <b>E:</b> EEPROM <b>S:</b> User Set

Factory Page

Display	Parameter name Description	Range	Default	Parameter Appears in Menu When	Modbus Relative Ad- dress	CIP Class Instance Attribute hex (dec)	Profibus Index	Data Type & Read/ Write
<b>roLL</b> [roLL]	<i>Security Setting</i> <b>Rolling Password</b> When power is cycled a new Public Key will be displayed.	<input type="checkbox"/> <b>OFF</b> Off <input type="checkbox"/> <b>ON</b> On	Off	Always	----	----	----	----
<b>PAS.u</b> [PAS.u]	<i>Security Setting</i> <b>User Password</b> Used to acquire access to menus made available through the Locked Access Level setting.	10 to 999	63	Always	----	----	----	----
<b>PAS.A</b> [PAS.A]	<i>Security Setting</i> <b>Administrator Password</b> Used to acquire full access to all menus.	10 to 999	156	Always	----	----	----	----
<b>ULoC</b> <b>FctY</b> <b>Security Setting Menu</b>								
<b>CodE</b> [CodE]	<i>Security Setting</i> <b>Public Key</b> If Rolling Password turned on, generates a random number when power is cycled. If Rolling Password is off fixed number will be displayed.	Customer Specific	0	Always	----	----	----	----
<b>PASS</b> [PASS]	<i>Security Setting</i> <b>Password</b> Number returned from calculation found in Features section under Password Security.	-1999 to 9999	0	Always	----	----	----	----
<b>d.r9</b> <b>FctY</b> <b>Diagnostics Menu</b>								
<b>Pn</b> [ Pn]	<i>Diagnostics Menu</i> <b>Part Number</b> Display this controller's part number.	15 characters	----	Instance 1 only	----	0x65 (101) 1 9	115	string RWE
<b>rEu</b> [ rEu]	<i>Diagnostics Menu</i> <b>Software Revision</b> Display this controller's firmware revision number.	1 to 10	----	Always	----	0x65 (101) 1 0x11 (17)	116	string R
<b>SbLd</b> [S.bLd]	<i>Diagnostics Menu</i> <b>Software Build Number</b> Display the firmware build number.	0 to 2,147,483,647	----	Always	<b>Instance 1</b> <i>Map 1    Map 2</i> 8            8	0x65 (101) 1 5	----	dint R
<b>Note:</b> Some values will be rounded off to fit in the four-character display. Full values can be read with other interfaces.								R: Read W: Write E: EEPROM S: User Set
<b>If there is only one instance of a menu, no submenus will appear.</b>								

Factory Page

Display	Parameter name Description	Range	Default	Parameter Appears in Menu When	Modbus Relative Address	CIP Class Instance Attribute hex (dec)	Profibus Index	Data Type & Read/Write
<b>5n</b> [ Sn]	<b>Diagnostics Menu</b> <b>Serial Number</b> Display the serial number.	0 to 2,147,483,647	----	----	----	0x65 (101) 1 0x20 (32)	----	string RWE
<b>dAtE</b> [dAtE]	<b>Diagnostics Menu</b> <b>Date of Manufacture</b> Display the date code.	0 to 2,147,483,647	----	----	<b>Instance 1</b> <i>Map 1</i> <i>Map 2</i> 14 14	0x65 (101) 1 8	----	dint RWE
<b>Cal</b> <b>FEY</b> <b>Calibration Menu</b>								
<b>MV</b> [ Mv]	<b>Calibration Menu (1 to 2)</b> <b>Electrical Measurement</b> Read the raw electrical value for this input in the units corresponding to the Sensor Type (Setup Page, Analog Input Menu) setting.	-3.4e38 to 3.4e38	----	Always	<b>Instance 1</b> <i>Map 1</i> <i>Map 2</i> 400 400 <b>Instance 2</b> <i>Map 1</i> <i>Map 2</i> 480 490	0x68 (104) 1 to 2 0x15 (21)	----	float R
<b>ELi.o</b> [ELi.o]	<b>Calibration Menu (1 to 2)</b> <b>Electrical Input Offset</b> Change this value to calibrate the low end of the input range.	-1,999.000 to 9,999.000	0.0	Always	<b>Instance 1</b> <i>Map 1</i> <i>Map 2</i> 378 378 <b>Instance 2</b> <i>Map 1</i> <i>Map 2</i> 458 468	0x68 (104) 1 to 2 0xA (10)	----	float RWES
<b>ELi.S</b> [ELi.S]	<b>Calibration Menu (1 to 2)</b> <b>Electrical Input Slope</b> Adjust this value to calibrate the slope of the input value.	-1,999.000 to 9,999.000	1.0	Always	<b>Instance 1</b> <i>Map 1</i> <i>Map 2</i> 380 380 <b>Instance 2</b> <i>Map 1</i> <i>Map 2</i> 460 470	0x68 (104) 1 to 2 0xB (11)	----	float RWES
<b>ELo.o</b> [ELo.o]	<b>Calibration Menu (1 or 3)</b> <b>Electrical Output Offset</b> Change this value to calibrate the low end of the output range. Menu 2 calibrates output 3.	-1,999.000 to 9,999.000	0.0	the controller has process outputs: 1 or 3	----	----	----	----
<b>Note:</b> Some values will be rounded off to fit in the four-character display. Full values can be read with other interfaces. <b>If there is only one instance of a menu, no submenus will appear.</b>								<b>R:</b> Read <b>W:</b> Write <b>E:</b> EEPROM <b>S:</b> User Set

### Factory Page

Display	Parameter name Description	Range	Default	Parameter Appears in Menu When	Modbus Relative Ad- dress	CIP Class Instance Attribute hex (dec)	Profibus Index	Data Type & Read/ Write
<b>ELoS</b> [ELoS]	<i>Calibration Menu (1 or 3)</i> <b>Electrical Output Slope</b> Adjust this value to calibrate the slope of the output value. Menu 2 calibrates output 3.	-1,999.000 to 9,999.000	1.0	the control- ler has process outputs: 1 or 3	----	----	----	----
<b>Note:</b> Some values will be rounded off to fit in the four-character display. Full values can be read with other interfaces.  <b>If there is only one instance of a menu, no submenus will appear.</b>								<b>R:</b> Read <b>W:</b> Write <b>E:</b> EEPROM <b>S:</b> User Set

# 9

## Chapter 9: Features

<b>Saving and Restoring User Settings</b> .....	<b>75</b>
<b>Programming the Home Page</b> .....	<b>75</b>
<b>Tuning the PID Parameters</b> .....	<b>75</b>
Manual Tuning .....	76
Autotuning with TRU-TUNE+® .....	76
<b>Inputs</b> .....	<b>77</b>
Calibration Offset .....	77
Calibration .....	77
Filter Time Constant .....	78
Sensor Selection .....	78
Set Point Low Limit and High Limit .....	78
Scale High and Scale Low .....	78
Range High and Range Low .....	78
<b>Outputs</b> .....	<b>78</b>
Duplex .....	78
NO-ARC Relay .....	79
Retransmitting a Process Value or Set Point .....	79
Cool Output Curve .....	79
<b>Control Methods</b> .....	<b>80</b>
Output Configuration .....	80
Auto (closed loop) and Manual (open loop) Control .....	80
On-Off Control .....	81
Proportional Control .....	81
Proportional plus Integral (PI) Control .....	81
Proportional plus Integral plus Derivative (PID) Control .....	82
Dead Band .....	82
Variable Time Base .....	82
Single Set Point Ramping .....	83
<b>Alarms</b> .....	<b>83</b>
Process and Deviation Alarms .....	83
Alarm Set Points .....	83
Alarm Hysteresis .....	84
Alarm Latching .....	84
Alarm Silencing .....	84
Alarm Blocking .....	84
<b>Programming the EZ Key/s</b> .....	<b>84</b>
<b>Using Lockout to Hide Pages and Menus</b> .....	<b>85</b>
Using Password Security .....	86

## Saving and Restoring User Settings

Recording setup and operations parameter settings for future reference is very important. If you unintentionally change these, you will need to program the correct settings back into the controller to return the equipment to operational condition.

After you program the controller and verify proper operation, use User Save Set **[USR.S]** (Factory Page, Diagnostics Menu) to save the settings into either of two files in a special section of memory. If the settings in the controller are altered and you want to return the controller to the saved values, use User Restore Set **[USR.R]** (Factory Page, Diagnostics Menu) to recall one of the saved settings.

A digital input or the Function Key can also be configured to restore parameters.

**Note:** Only perform the above procedure when you are sure that all the correct settings are programmed into the controller. Saving the settings overwrites any previously saved collection of settings. Be sure to document all the controller settings.

## Programming the Home Page

Watlow's patented user-defined menu system improves operational efficiency. The user-defined Home Page provides you with a shortcut to monitor or change the parameter values that you use most often.

You can create your own Home Page with as many as 20 of the active parameters. When a parameter normally located in the Setup Page or Operations Page is placed in the Home Page, it is accessible through both. If you change a parameter in the Home Page, it is automatically changed in its original page. If you change a parameter in its original page it is automatically changed in the Home Page.

The default parameters will automatically appear in the Home Page.

Change the list of parameters in the Home Page from the Custom Menu **[CUSE]** (Factory Page).

## Tuning the PID Parameters

### Autotuning

When an autotune is performed on the EZ-ZONE PM, the set point is used to calculate the tuning set point.

For example, if the active set point is 200° and Autotune Set Point **[AESP]** (Operations Page, Loop Menu) is set to 90 percent, the autotune function utilizes 180° for tuning. This is also how autotuning works in previous Watlow Winona controllers. In addition, changing the active set point in previous controllers causes the autotune function to restart; where with the EZ-ZONE PM changing the set point after an autotune has been started has no affect.

A new feature in EZ-ZONE PM products will allow set point changes while the control is autotuning, this includes while running a profile or ramping. When the auto tune is initially started it will use the current set point and will disregard all set point changes until the tuning process is complete. Once complete, the controller will then use the new set point.

This is why it is a good idea to enter the active set point before initiating an autotune.

Autotuning calculates the optimum heating and/or cooling PID parameter settings based on the system's response. Autotuning can be enabled whether or not TUNE-TUNE+® is enabled. The PID settings generated by the autotune will be used until the autotune feature is rerun, the PID values are manually adjusted or TRU-TUNE+® is enabled.

To initiate an autotune, set Autotune Request **[AUT]** (Operations Page, Loop Menu) to **[YES]**. You should not autotune while a profile is running. If the autotune cannot be completed in 60 minutes, the autotune will time-out and the original settings will take effect.

The lower display will flash between **[TUNE]** and the set point while the autotuning is underway. The temperature must cross the Autotune Set Point five times to complete the autotuning process. Once complete, the controller controls at the normal set point, using the new parameters.

Select a set point for the tune with Autotune Set Point. The Autotune Set Point is expressed as a percent of the Closed Loop Set Point.

If you need to adjust the tuning procedure's aggressiveness, use Autotune Aggressiveness **[AAGR]** (Setup Page, Loop Menu). Select under damped **[Undr]** to bring the process value to the set point quickly. Select over damped **[over]** to bring the process value to the set point with minimal overshoot. Select critical damped **[CrE]** to balance a rapid response with minimal overshoot.

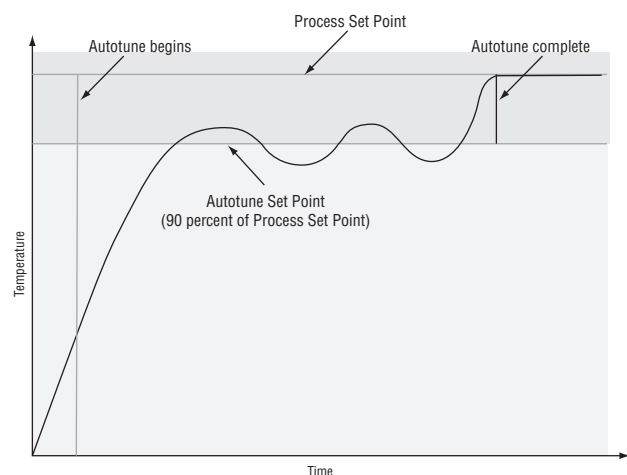

## Manual Tuning

In some applications, the autotune process may not provide PID parameters for the process characteristics you desire. If that is the case, you may want to tune the controller manually.

1. Apply power to the controller and establish a set point typically used in your process.
2. Go to the Operations Page, Loop Menu, and set Heat Proportional Band  and/or Cool Proportional Band  to 5. Set Time Integral  to 0. Set Time Derivative  to 0.
3. When the system stabilizes, watch the process value. If it fluctuates, increase the Heat Proportional Band or Cool Proportional Band value in 3 to 5° increments until it stabilizes, allowing time for the system to settle between adjustments.
4. When the process has stabilized, watch Heat Power  or Cool Power  (Operations Page, Monitor Menu). It should be stable  $\pm 2\%$ . At this point, the process temperature should also be stable, but it will have stabilized before reaching the set point. The difference between the set point and actual process value can be eliminated with Integral.
5. Start with an Integral value of 6,000 and allow 10 minutes for the process temperature to reach the set point. If it has not, reduce the setting by half and wait another 10 minutes. Continue reducing the setting by half every 10 minutes until the process value equals the set point. If the process becomes unstable, the Integral value is too small. Increase the value until the process stabilizes.
6. Increase Derivative to 0.1. Then increase the set point by 11° to 17°C. Monitor the system's approach to the set point. If the process value overshoots the set point, increase Derivative to 0.2. Increase the set point by 11° to 17°C and watch the approach to the new set point. If you increase Derivative too much, the approach to the set point will be very sluggish. Repeat as necessary until the system rises to the new set point without overshoot or sluggishness.

For additional information about autotune and PID control, see related features in this chapter.

---

### Autotuning with TRU-TUNE+®

The TRU-TUNE+® adaptive algorithm will optimize the controller's PID values to improve control of dynamic processes. TRU-TUNE+® monitors the process variable and adjusts the control parameters automatically to keep your process at set point during set point and load changes. When the controller is in the adaptive control mode, it determines the appropriate output signal and, over time, adjusts control parameters to optimize responsiveness and stability. The TRU-TUNE+® feature does not function for on-off control.

The preferred and quickest method for tuning a loop is to establish initial control settings and continue with the adaptive mode to fine tune the settings.

Setting a controller's control mode to tune starts this two-step tuning process. (See Autotuning in this chapter.) This predictive tune determines initial, rough settings for the PID parameters. Then the loop automatically switches to the adaptive mode which fine tunes the PID parameters.

Once the process variable has been at set point for a suitable period (about 30 minutes for a fast process to roughly two hours for a slower process) and if no further tuning of the PID parameters is desired or needed, TRU-TUNE+® may be turned off. However, keeping the controller in the adaptive mode allows it to automatically adjust to load changes and compensate for differing control characteristics at various set points for processes that are not entirely linear.

Once the PID parameters have been set by the TRU-TUNE+® adaptive algorithm, the process, if shut down for any reason, can be restarted in the adaptive control mode.

Turn TRU-TUNE+® on or off with TRU-TUNE+® Enable  (Setup Page, Loop Menu).

Use TRU-TUNE+® Band  (Setup Page, Loop Menu) to set the range above and below the set point in which adaptive tuning will be active. Adjust this parameter only in the unlikely event that the controller is unable to stabilize at the set point with TRU-TUNE+® Band set to auto (0). This may occur with very fast processes. In that case, set TRU-TUNE+™ Band to a large value, such as 100.

Use TRU-TUNE+® Gain  (Setup Page, Loop Menu) to adjust the responsiveness of the adaptive tuning calculations. Six settings range from 1, with the most aggressive response and most potential overshoot (highest gain), to 6, with the least aggressive response and least potential for overshoot (lowest gain). The default setting, 3, is recommended for loops with thermocouple feedback and moderate response and overshoot potential.

### Before Tuning

Before autotuning, the controller hardware must be installed correctly, and these basic configuration parameters must be set:

- Sensor Type  (Setup Page, Analog Input Menu), and scaling, if required;
- Function  (Setup Page, Output Menu) and scaling, if required.

### How to Autotune a Loop

1. Enter the desired set point or one that is in the middle of the expected range of set points that you want to tune for.
2. Enable TRU-TUNE+®.
3. Initiate an autotune. (See Autotuning in this chapter.)



When autotuning is complete, the PID parameters should provide good control. As long as the loop is in the adaptive control mode, TRU-TUNE+® continuously tunes to provide the best possible PID control for the process.



**WARNING!** During autotuning, the controller sets the output to 100 percent and attempts to drive the process variable toward the set point. Enter a set point and heat and cool power limits that are within the safe operating limits of your system.

## Inputs

### Calibration Offset

Calibration offset allows a device to compensate for an inaccurate sensor, lead resistance or other factors that affect the input value. A positive offset increases the input value, and a negative offset decreases the input value.

The input offset value can be viewed or changed with Calibration Offset  (Operations Page, Analog Input Menu).

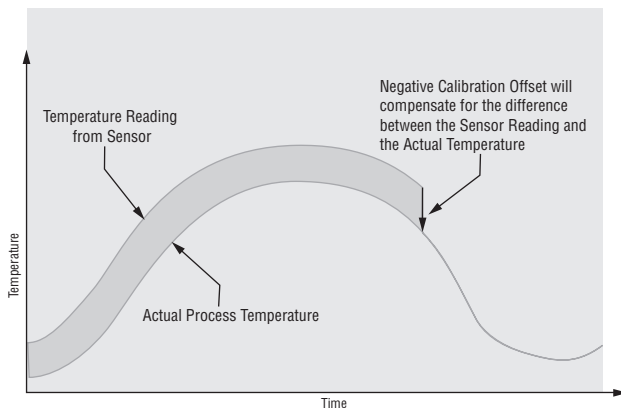

### Calibration

To calibrate an analog input, you will need to provide two electrical signals or resistance loads near the extremes of the range that the application is likely to utilize. See recommended values below:

Sensor Type	Low Source	High Source
thermocouple	0.000 mV	50.000 mV
millivolts	0.000 mV	50.000 mV
volts	0.000V	10.000V
milliamps	0.000 mA	20.000 mA
100 Ω RTD	50.00 Ω	350.00 Ω
1,000 Ω RTD	500.00 Ω	3,500.00 Ω
Thermistor 5K	50.00 Ω	5000.00 Ω
Thermistor 10K	50.00 Ω	10000.00 Ω
Thermistor 20K	50.00 Ω	20000.00 Ω
Thermistor 40K	50.00 Ω	40000.00 Ω

### Follow these steps for a thermocouple or process input:

1. Apply the low source signal to the input you are calibrating. Measure the signal to ensure it is accurate.
2. Read the value of Electrical Measurement  (Factory Page, Calibration Menu) for that input.
3. Calculate the offset value by subtracting this value from the low source signal.
4. Set Electrical Input Offset  (Factory Page, Calibration Menu) for this input to the offset value.
5. Check the Electrical Measurement to see whether it now matches the signal. If it doesn't match, adjust Electrical Input Offset again.
6. Apply the high source signal to the input. Measure the signal to ensure it is accurate.
7. Read the value of Electrical Measurement for that input.
8. Calculate the gain value by dividing the low source signal by this value.
9. Set Electrical Input Slope  (Factory Page, Calibration Menu) for this input to the calculated gain value.
10. Check the Electrical Measurement to see whether it now matches the signal. If it doesn't match, adjust Electrical Input Slope again.

Set Electrical Input Offset to 0 and Electrical Input Slope to 1 to restore factory calibration.

### Follow these steps for an RTD input:

1. Measure the low source resistance to ensure it is accurate. Connect the low source resistance to the input you are calibrating.
2. Read the value of Electrical Measurement  (Factory Page, Calibration Menu) for that input.
3. Calculate the offset value by subtracting this value from the low source resistance.
4. Set Electrical Input Offset  (Factory Page, Calibration Menu) for this input to the offset value.
5. Check the Electrical Measurement to see whether it now matches the resistance. If it doesn't match, adjust Electrical Offset again.
6. Measure the high source resistance to ensure it is accurate. Connect the high source resistance to the input.
7. Read the value of Electrical Measurement for that input.
8. Calculate the gain value by dividing the low source signal by this value.
9. Set Electrical Input Slope  (Factory Page, Calibration Menu) for this input to the calculated gain value.
10. Check the Electrical Measurement to see whether it now matches the signal. If it doesn't match, adjust Electrical Input Slope again.

Set Electrical Input Offset to 0 and Electrical Input Slope to 1 to restore factory calibration.

## Filter Time Constant

Filtering smoothes an input signal by applying a first-order filter time constant to the signal. Filtering the displayed value makes it easier to monitor. Filtering the signal may improve the performance of PID control in a noisy or very dynamic system.

Adjust the filter time interval with Filter Time  (Setup Page, Analog Input Menu).

Example: With a filter value of 0.5 seconds, if the process input value instantly changes from 0 to 100 and remained at 100, the display will indicate 100 after five time constants of the filter value or 2.5 seconds.

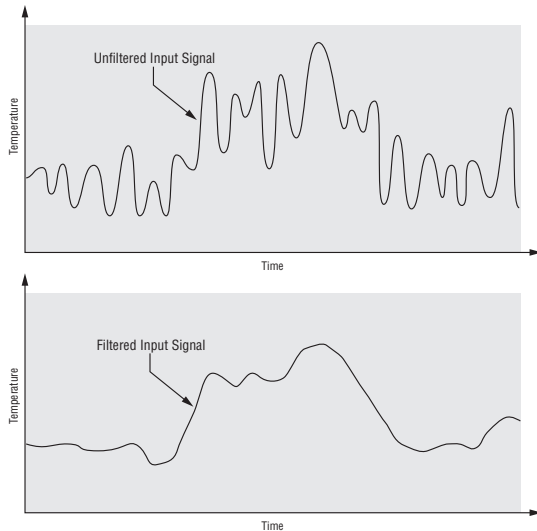

## Sensor Selection

You need to configure the controller to match the input device, which is normally a thermocouple, RTD or process transmitter.

Select the sensor type with Sensor Type  (Setup Page, Analog Input Menu).

## Set Point Low Limit and High Limit

The controller constrains the set point to a value between a set point low limit and a set point high limit.

Set the set point limits with Low Set Point  and High Set Point  (Setup Page, Loop Menu).

There are two sets of set point low and high limits: one for a closed-loop set point, another for an open-loop set point.

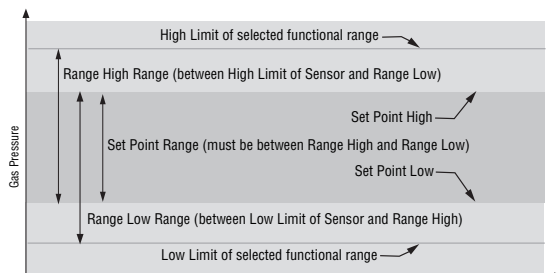

## Scale High and Scale Low

When an analog input is selected as process voltage or process current input, you must choose the value of voltage or current to be the low and high ends. For example, when using a 4 to 20 mA input, the scale low value would be 4.00 mA and the scale high value would be 20.00 mA. Commonly used scale ranges are: 0 to 20 mA, 4 to 20 mA, 0 to 5V, 1 to 5V and 0 to 10V.

You can create a scale range representing other units for special applications. You can reverse scales from high values to low values for analog input signals that have a reversed action. For example, if 50 psi causes a 4 mA signal and 10 psi causes a 20 mA signal.

Scale low and high low values do not have to match the bounds of the measurement range. These along with range low and high provide for process scaling and can include values not measureable by the controller. Regardless of scaling values, the measured value will be constrained by the electrical measurements of the hardware.

Select the low and high values with Scale Low  and Scale High . Select the displayed range with Range Low  and Range High  (Setup Page, Analog Input Menu).

## Range High and Range Low

With a process input, you must choose a value to represent the low and high ends of the current or voltage range. Choosing these values allows the controller's display to be scaled into the actual working units of measurement. For example, the analog input from a humidity transmitter could represent 0 to 100 percent relative humidity as a process signal of 4 to 20 mA. Low scale would be set to 0 to represent 4 mA and high scale set to 100 to represent 20 mA. The indication on the display would then represent percent humidity and range from 0 to 100 percent with an input of 4 to 20 mA.

Select the low and high values with Range Low  and Range High  (Setup Page, Analog Input Menu).

## Outputs

### Duplex

Certain systems require that a single process output control both heating and cooling outputs. An EZ-ZONE® PM controller with a process output can function as two separate outputs.

With a 4 to 20mA output the heating output will operate from 12 to 20mA (0 to +100 percent) and the cooling output will operate from 12 to 4mA (0 to -100 percent).

In some cases this type of output is required by the device that the EZ-ZONE PM controls, such as a three-way valve that opens one way with a 12 to 20mA signal and opens the other way with a 4 to

12mA signal. This feature reduces the overall system cost by using a single output to act as two outputs.

Outputs 1 and 3 can be ordered as process outputs. Select duplex **DUPL** as the Output Function **Fn** (Setup Page, Output Menu). Set the output to volts **VOLT** or milliamps **MA** with Output Type **OUTY**. Set the range of the process output with Scale Low **SL0** and Scale High **SH1**.

---

## NO-ARC Relay

A NO-ARC relay provides a significant improvement in the life of the output relay over conventional relays.

Conventional mechanical relays have an expected life of 100,000 cycles at the rated full-load current. The shorter life for conventional relays is due to the fact that when contacts open while current is flowing metal degradation occurs. This action produces unavoidable electrical arcing causing metal to transfer from one contact to the other. The arcing conditions continue on each subsequent contact opening until over time the resistance through the contacts increases causing the contacts to increase in temperature. Eventually, the contacts will weld together and the relay remains in the on state.

The Watlow NO-ARC relay is a hybrid relay. It uses a mechanical relay for the current load and a triac (solid-state switch) to carry the turn-on and turn-off currents. NO-ARC relays extend the life of the relay more than two million cycles at the rated full-load current.

Although a NO-ARC relay has significant life advantages, a few precautions must be followed for acceptable usage:

### Do not use:

- hybrid relays for limit contactors. A limit or safety device must provide a positive mechanical break on all hot legs simultaneously;
- dc loads with hybrid relays. The triacs used for arc suppression will turn off only with ac line voltage;
- hybrid switches to drive any inductive loads, such as relay coils, transformers or solenoids;
- cycle times less than five seconds on hybrid switches;
- on loads that exceed 264V ac through relay;
- on loads that exceed 15 amperes load;
- on loads less than 100 mA;
- NO-ARC relays in series with other NO-ARC relays.

---

## Retransmitting a Process Value or Set Point

The retransmit feature allows a process output to provide an analog signal that represents the set point or process value. The signal may serve as a remote set point for another controller or as an in-

put for a chart recorder documenting system performance over time.

In choosing the type of retransmit signal the operator must take into account the input impedance of the device to be retransmitted to and the required signal type, either voltage or milliamps.

Typically applications might use the retransmit option to record one of the variables with a chart recorder or to generate a set point for other controls in a multi-zone application.

Output 1 can be ordered as process outputs. Select retransmit **RETE** as the Output Function **Fn** (Setup Page, Output Menu). Set the output to volts **VOLT** or milliamps **MA** with Output Type **OUTY**. Select the signal to retransmit with Retransmit Source **RSR**.

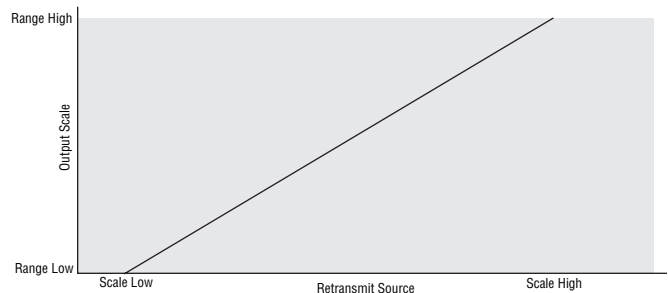

Set the range of the process output with Scale Low **SL0** and Scale High **SH1**. Scale the retransmit source to the process output with Range Low **RL0** and Range High **RH1**.

When the retransmit source is at the Range Low value, the retransmit output will be at its Scale Low value. When the retransmit source is at the Range High value, the retransmit output will be at its Scale High value.

---

## Cool Output Curve

A nonlinear output curve may improve performance when the response of the output device is nonlinear. If a cool output uses one of the nonlinear curves a PID calculation yields a lower actual output level than a linear output would provide.

These output curves are used in plastics extruder applications: curve 1 for oil-cooled extruders and curve 2 for water-cooled extruders.

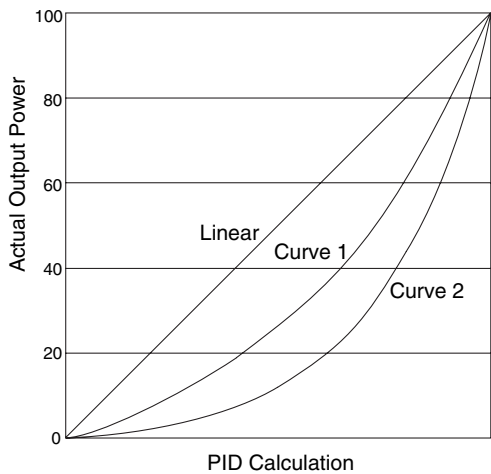

Select a nonlinear cool output curve with Cool Output Curve **[CLR]** (Setup Menu, Loop Menu).

## Control Methods

### Output Configuration

Each controller output can be configured as a heat output, a cool output, an alarm output or deactivated. No dependency limitations have been placed on the available combinations. The outputs can be configured in any combination. For instance, all three could be set to cool.

Heat and cool outputs use the set point and Operations parameters to determine the output value. All heat and cool outputs use the same set point value. Heat and cool each have their own set of control parameters. All heat outputs use the same set of heat control parameters and all cool outputs use the same set of cool output parameters.

Each alarm output has its own set of configuration parameters and set points, allowing independent operation.

### Auto (closed loop) and Manual (open loop) Control

The controller has two basic modes of operation, auto mode and manual mode. Auto mode allows the controller to decide whether to perform closed-loop control or to follow the settings of Input Error Failure **[FRIL]** (Setup Page, Loop Menu). The manual mode only allows open-loop control. The EZ-ZONE PM controller is normally used in the auto mode. The manual mode is usually only used for specialty applications or for troubleshooting.

Manual mode is open-loop control that allows the user to directly set the power level to the controller's output load. No adjustments of the output power level occur based on temperature or set point in this mode.

In auto mode, the controller monitors the input to determine if closed-loop control is possible. The controller checks to make certain a functioning sensor is providing a valid input signal. If a valid input signal

is present, the controller will perform closed-loop control. Closed-loop control uses a process sensor to determine the difference between the process value and the set point. Then the controller applies power to a control output load to reduce that difference.

If a valid input signal is not present, the controller will indicate an input error message in the upper display and **[RELn]** in the lower display and respond to the failure according to the setting of Input Error Failure **[FRIL]**. You can configure the controller to perform a "bumpless" transfer **[BPLS]**, switch power to output a preset fixed level **[PRRn]**, or turn the output power off.

Bumpless transfer will allow the controller to transfer to the manual mode using the last power value calculated in the auto mode if the process had stabilized at a  $\pm 5$  percent output power level for the time interval of Time Integral (Operations Page, Loop) prior to sensor failure, and that power level is less than 75 percent.

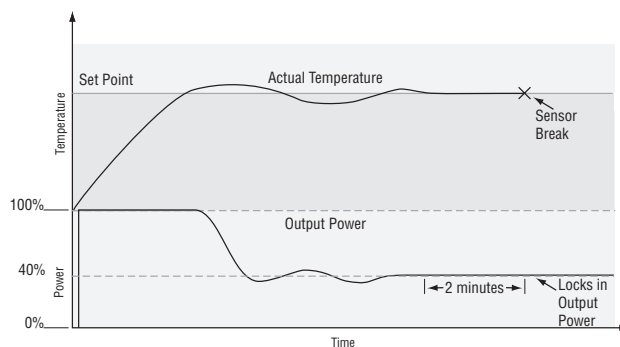

Input Error Latching **[IER]** (Setup Page, Analog Input Menu) determines the controller's response once a valid input signal returns to the controller. If latching is on, then the controller will continue to indicate an input error until the error is cleared. To clear a latched alarm, press the Advance Key **[FWD]** then the Up Key **[UP]**.

If latching is off, the controller will automatically clear the input error and return to reading the temperature. If the controller was in the auto mode when the input error occurred, it will resume closed-loop control. If the controller was in manual mode when the error occurred, the controller will remain in open-loop control.

The Manual Control Indicator Light % is on when the controller is operating in manual mode.

You can easily switch between modes if the Control Mode **[CR7]** parameter is selected to appear in the Home Page.

To transfer to manual mode from auto mode, press the Advance Key **[FWD]** until **[CR7]** appears in the lower display. The upper display will display **[AUTO]** for auto mode. Use the Up **[UP]** or Down **[DN]** keys to select **[PRRn]**. The manual set point value will be recalled from the last manual operation.

To transfer to auto mode from manual mode, press the Advance Key **[FWD]** until **[CR7]** appears in the lower display. The upper display will display



**MAN** for manual mode. Use the Up  $\blacktriangle$  or Down  $\blacktriangledown$  keys to select **AUTO**. The automatic set point value will be recalled from the last automatic operation.

Changes take effect after three seconds or immediately upon pressing either the Advance Key  $\odot$  or the Infinity Key  $\infty$ .

## On-Off Control

On-off control switches the output either full on or full off, depending on the input, set point and hysteresis values. The hysteresis value indicates the amount the process value must deviate from the set point to turn on the output. Increasing the value decreases the number of times the output will cycle. Decreasing hysteresis improves controllability. With hysteresis set to 0, the process value would stay closer to the set point, but the output would switch on and off more frequently, and may result in the output “chattering.”

On-off control can be selected with Heat Algorithm **HA9** or Cool Algorithm **CA9** (Setup Page, Loop Menu).

On-off hysteresis can be set with Heat Hysteresis **HH9** or Cool Hysteresis **CH9** (Operations Page, Loop Menu).

### Note:

**Input Error Failure Mode (FAIL)** does not function in on-off control mode. The output goes off.

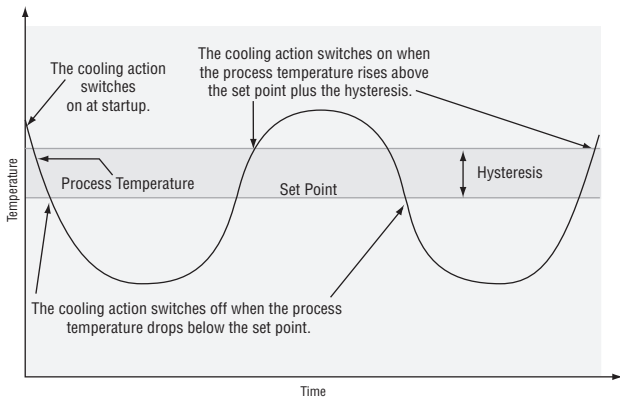
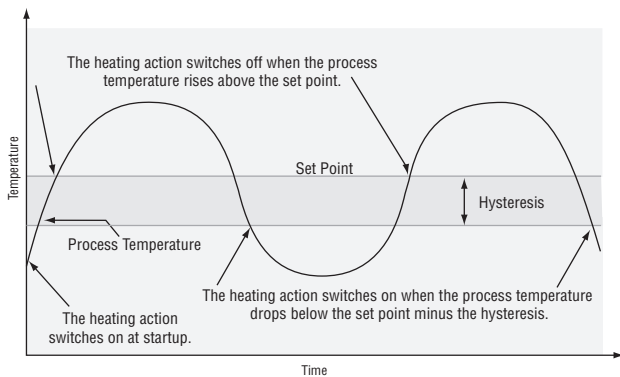

## Proportional Control

Some processes need to maintain a temperature or process value closer to the set point than on-off control can provide. Proportional control provides closer control by adjusting the output when the temperature or process value is within a proportional band. When the value is in the band, the controller adjusts the output based on how close the process value is to the set point.

The closer the process value is to the set point, the lower the output power. This is similar to backing off on the gas pedal of a car as you approach a stop sign. It keeps the temperature or process value from swinging as widely as it would with simple on-off control. However, when the system settles down, the temperature or process value tends to “droop” short of the set point.

With proportional control the output power level equals (set point minus process value) divided by the proportional band value.

In an application with one output assigned to heating and another assigned to cooling, each will have a separate proportional parameter. The heating parameter takes effect when the process temperature is lower than the set point, and the cooling parameter takes effect when the process temperature is higher than the set point.

Adjust the proportional band with Heat Proportional Band **hPb** or Cool Proportional Band **CPb** (Operations Page, Loop Menu).

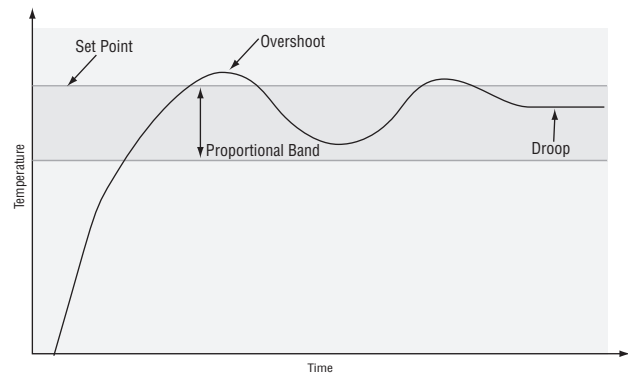

## Proportional plus Integral (PI) Control

The droop caused by proportional control can be corrected by adding integral (reset) control. When the system settles down, the integral value is tuned to bring the temperature or process value closer to the set point. Integral determines the speed of the correction, but this may increase the overshoot at startup or when the set point is changed. Too much integral action will make the system unstable. Integral is cleared when the process value is outside of the proportional band.

Adjust the integral with Time Integral **t<sub>i</sub>** (Operations Page, Loop Menu).

## Proportional plus Integral plus Derivative (PID) Control

Use derivative (rate) control to minimize the overshoot in a PI-controlled system. Derivative (rate) adjusts the output based on the rate of change in the temperature or process value. Too much derivative (rate) will make the system sluggish.

Derivative action is active only when the process value is within twice the proportional value from the set point.

Adjust the derivative with Time Derivative

(Operations Page, Loop Menu).

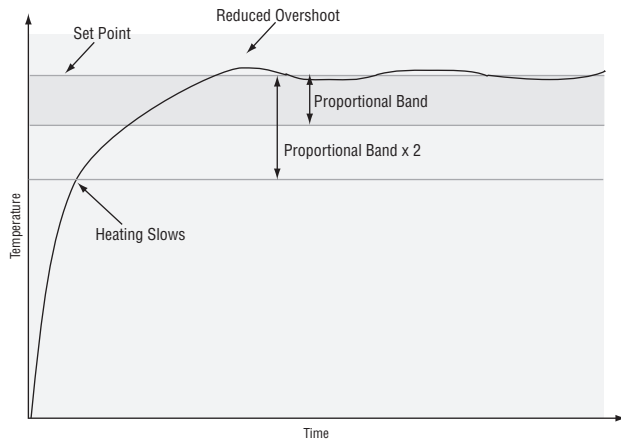

## Dead Band

In a PID application the dead bands above and below the set point can save an application's energy and wear by maintaining process temperature within acceptable ranges.

Proportional action ceases when the process value is within the dead band. Integral action continues to bring the process temperature to the set point.

Using a **positive dead band value** keeps the two systems from fighting each other.

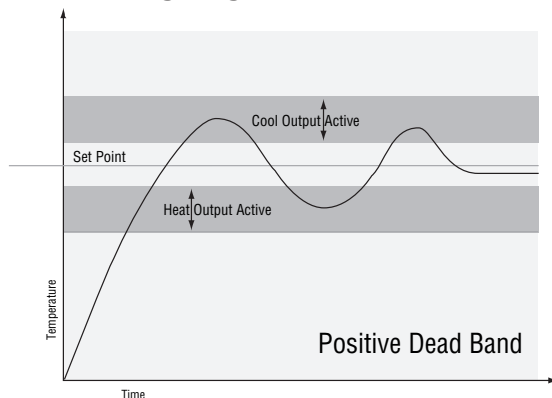

When the **dead band value is zero**, the heating output activates when the temperature drops below the set point, and the cooling output switches on when the temperature exceeds the set point.

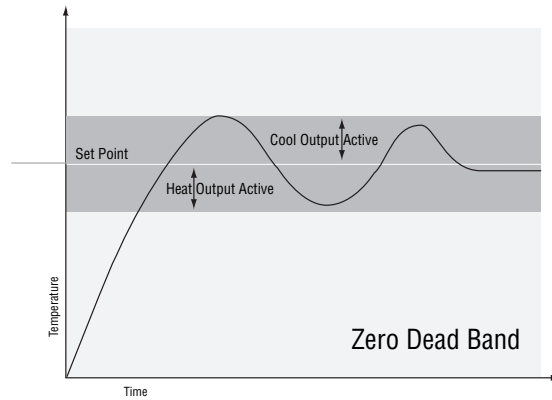

When the **dead band value is a negative value**, both heating and cooling outputs are active when the temperature is near the set point.

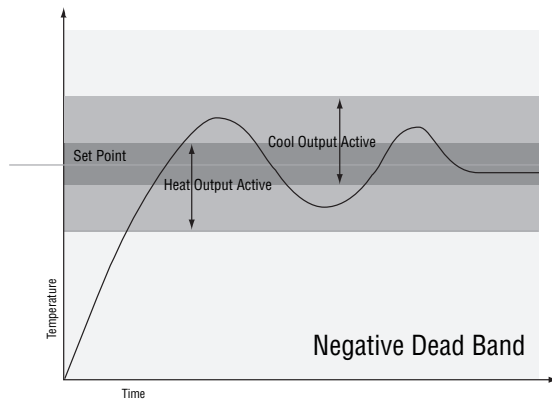

Adjust the dead band with Dead Band  (Operations Page, Loop Menu).

## Variable Time Base

Variable time base is the preferred method for controlling a resistive load, providing a very short time base for longer heater life. Unlike phase-angle firing, variable-time-base switching does not limit the current and voltage applied to the heater.

With variable time base outputs, the PID algorithm calculates an output between 0 and 100%, but the output is distributed in groupings of three ac line cycles. For each group of three ac line cycles, the controller decides whether the power should be on or off. There is no fixed cycle time since the decision is made for each group of cycles. When used in conjunction with a zero cross (burst fire) device, such as a solid-state power controller, switching is done only at the zero cross of the ac line, which helps reduce electrical noise (RFI).

Variable time base should be used with solid-state power controllers, such as a solid-state relay (SSR) or silicon controlled rectifier (SCR) power controller. Do not use a variable time base output for controlling electromechanical relays, mercury displacement relays, inductive loads or heaters with unusual resistance characteristics.

The combination of variable time base output and a solid-state relay can inexpensively approach the ef-

fect of analog, phase-angle fired control.

Select the AC Line Frequency **ACLF** (Setup Page, Global Menu), 50 or 60 Hz.

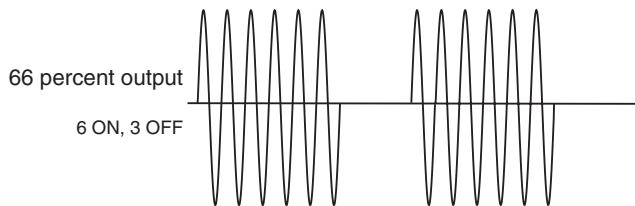
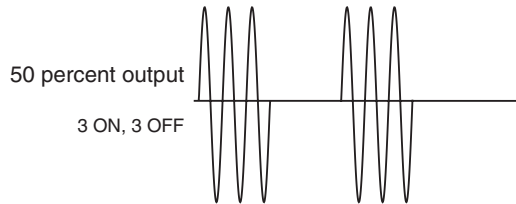
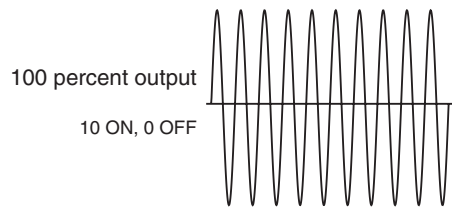

**Note:**

**When output 1 is a universal process output, output 2 cannot use variable time base, fixed time base only.**

### Single Set Point Ramping

Ramping protects materials and systems that cannot tolerate rapid temperature changes. The value of the ramp rate is the maximum degrees per minute or hour that the system temperature can change.

Select Ramp Action  **rP** (Setup Page, Loop Menu):

- OFF** ramping not active.
- Stc** ramp at startup.
- SEPE** ramp at a set point change.
- both** ramp at startup or when the set point changes.

Select whether the rate is in degrees per minute or degrees per hour with Ramp Scale  **rSC**. Set the ramping rate with Ramp Rate  **rRt** (Setup Page, Loop Menu).

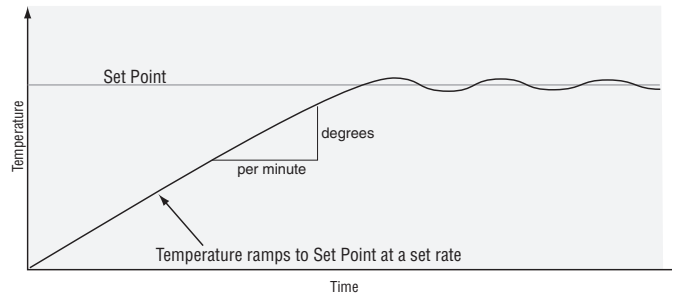
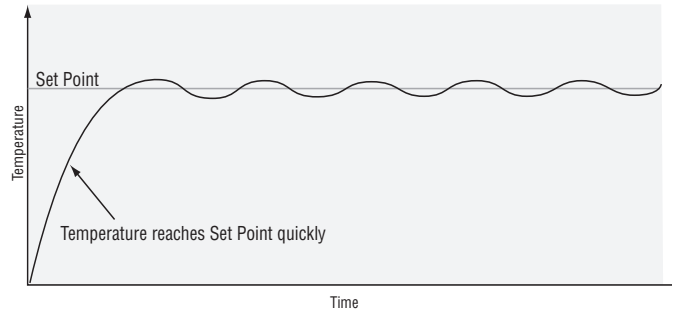

### Alarms

Alarms are activated when the output level, process value or temperature leaves a defined range. A user can configure how and when an alarm is triggered, what action it takes and whether it turns off automatically when the alarm condition is over.

Configure alarm outputs in the Setup Page before setting alarm set points.

Alarms do not have to be assigned to an output. Alarms can be monitored and controlled through the front panel or by using software.

### Process and Deviation Alarms

A process alarm uses one or two absolute set points to define an alarm condition.

A deviation alarm uses one or two set points that are defined relative to the control set point. High and low alarm set points are calculated by adding or subtracting offset values from the control set point. If the set point changes, the window defined by the alarm set points automatically moves with it.

Select the alarm type with Type  **ALY** (Setup Page, Alarm Menu).

### Alarm Set Points

The alarm high set point defines the process value or temperature that will trigger a high side alarm. It must be higher than the alarm low set point and lower than the high limit of the sensor range.

The alarm low set point defines the temperature that will trigger a low side alarm. It must be lower than the alarm high set point and higher than the low limit of the sensor range.



View or change alarm set points with Low Set Point **[RLo]** and High Set Point **[RHi]** (Operations Page, Alarm Menu).

## Alarm Hysteresis

An alarm state is triggered when the process value reaches the alarm high or alarm low set point. Alarm hysteresis defines how far the process must return into the normal operating range before the alarm can be cleared.

Alarm hysteresis is a zone inside each alarm set point. This zone is defined by adding the hysteresis value to the alarm low set point or subtracting the hysteresis value from the alarm high set point.

View or change alarm hysteresis with Hysteresis **[RHy]** (Setup Page, Alarm Menu).

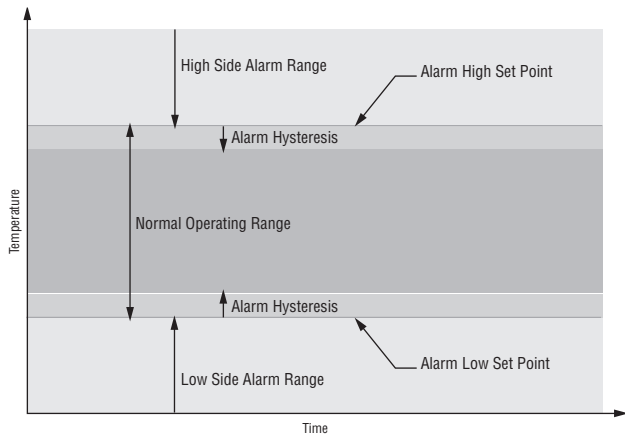

## Alarm Latching

A latched alarm will remain active after the alarm condition has passed. It can only be deactivated by the user.

An active message, such as an alarm message, will cause the display to toggle between the normal settings and the active message in the upper display and **[REEn]** in the lower display.

Push the Advance Key to display **[,9nc]** in the upper display and the message source in the lower display.

Use the Up **▲** and Down **▼** keys to scroll through possible responses, such as Clear **[CLR]** or Silence **[SIL]**. Then push the Advance **⊗** or Infinity **⊕** key to execute the action.

See the Keys and Displays chapter and the Home Page chapter for more details.

An alarm that is not latched (self-clearing) will deactivate automatically when the alarm condition has passed.

Turn alarm latching on or off with Latching **[RLA]** (Setup Page, Alarm Menu).

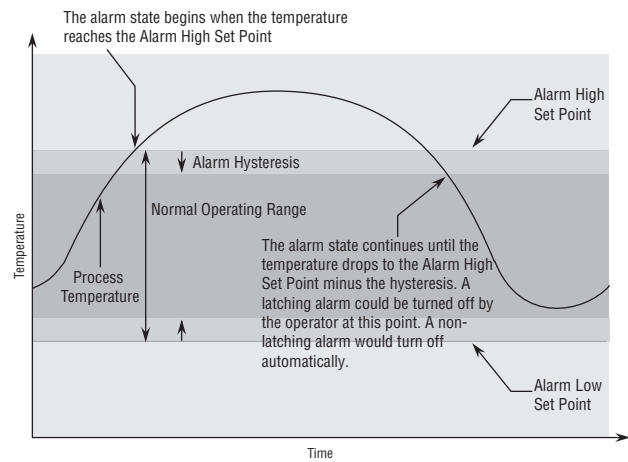

## Alarm Silencing

If alarm silencing is on the operator can disable the alarm output while the controller is in an alarm state. The process value or temperature has to enter the normal operating range beyond the hysteresis zone to activate the alarm output function again.

An active message, such as an alarm message, will cause the display to toggle between the normal settings and the active message in the upper display and **[REEn]** in the lower display.

Push the Advance Key to display **[,9nc]** in the upper display and the message source in the lower display.

Use the Up **▲** and Down **▼** keys to scroll through possible responses, such as Clear **[CLR]** or Silence **[SIL]**. Then push the Advance **⊗** or Infinity **⊕** key to execute the action.

See the Keys and Displays chapter and the Home Page chapter for more details.

Turn alarm silencing on or off with Silencing **[RS]** (Setup Page, Alarm Menu).

## Alarm Blocking

Alarm blocking allows a system to warm up after it has been started up. With alarm blocking on, an alarm is not triggered when the process temperature is initially lower than the alarm low set point or higher than the alarm high set point. The process temperature has to enter the normal operating range beyond the hysteresis zone to activate the alarm function.

If the EZ-ZONE PM has an output that is functioning as a deviation alarm, the alarm is blocked when the set point is changed, until the process value re-enters the normal operating range.

Turn alarm blocking on or off with Blocking **[RbL]** (Setup Page, Alarm Menu).











## Programming the EZ Key/s

You can program the EZ Key either in the Setup Menu or with configuration software, such as EZ-

ZONE Configurator, using a personal computer.

The following examples show how to program the EZ Key to start and stop a profile.

### Using keys and display:

- To go to the Setup Page from the Home Page, press both the Up  and Down  keys for six seconds. **SET** will appear in the upper display and **SET** will appear in the lower display.
- Press the Up Key  until **Fun** appears in the upper display and **SET** will appear in the lower display.
- Press the Advance Key  until Digital Input Level **LEU** appears in the lower display. Use an arrow key to specify the state of the key (high or low) when the controller is powered up. Functions will toggle with each press of the EZ Key, such as Profile Start/Stop.
- Press the Advance Key . The lower display will show Digital Function **Fn**. Press the Up  or Down  key to scroll through the functions that can be assigned to the EZ Key  
When Profile Start/Stop **PSES** appears in the upper display and **Fn** appears in the lower display, press the Advance Key  once to select that function and move to the Function Instance **FS** parameter.
- Press the Up  or Down  key to scroll to the profile that you want the EZ Key to control.
- The instance tells the controller which of the numbered functions should be acted upon. For profiles, there are 4 instances. Press the Infinity Key  once to return to the submenu, twice to return to the main menu or three times to return to the Home Page.

### Using the software with Standard Bus:

- Make the necessary physical connections between the personal computer and the EZ-ZONE PM. Set Protocol (Setup Page, Communications Menu) to Standard Bus. Run the software and allow it to connect to the controller by directing it or allowing it to find the appropriate communications port.
- After the software connects to the controller, look on the left side of your screen under the Parameters Menus for Function Key under Setup. Click on the plus sign to reveal the Function Key 1 submenu.
- Click on Function Key 1, then select a Digital In-

put Function and a Function Instance.

If you want to start and stop a profile with the EZ Key, select Profile Start/Stop and the number of the profile that you want the EZ Key to control.

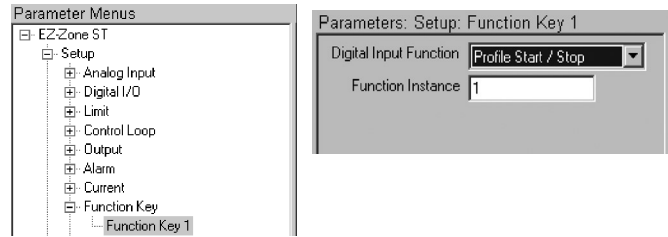

### Using Lockout to Hide Pages and Menus

If unintentional changes to parameter settings might raise safety concerns or lead to downtime, you can use the lockout feature to make them more secure.

Each of the menus in the Factory Page and each of the pages, except the Factory Page, has a security level assigned to it. You can change the read and write access to these menus and pages by using the parameters in the Lockout Menu (Factory Page).

#### Lockout Menu

There are five parameters in the Lockout Menu (Factory Page):

- Lock Operations Page **LoLo** sets the security level for the Operations Page. (default: 2)

#### Note:

The Home and Setup Page lockout levels are fixed and cannot be changed.

- Lock Profiling Page **LoLP** sets the security level for the Profiling Page. (default: 3)
- Password Security Enable **PARSE** will turn on or off the Password security feature. (default: off)
- Read Lockout Security **rLoL** determines which pages can be accessed. The user can access the selected level and all lower levels. (default: 5)
- Set Lockout Security **SLoL** determines which parameters within accessible pages can be written to. The user can write to the selected level and all lower levels. (default: 5)

The table below represents the various levels of lockout for the Set Lockout Security prompt and the Read Lockout Security prompt. The Set Lockout has 6 levels (0-5) of security where the Read Lockout has 5 (1-5). Therefore, level "0" applies to Set Lockout only. "Y" equates to yes (can write/read) where "N" equates to no (cannot write/read). The colored cells differentiate one level from the next.

Lockout Security $SLoL$ & $rLoL$						
Lockout Level	0	1	2	3	4	5
Home Page	Y	Y	Y	Y	Y	Y
Operations Page	N	N	Y	Y	Y	Y
Setup Page	N	N	N	N	Y	Y
Profile Page	N	N	N	Y	Y	Y
Factory Page						
Custom Menu	N	N	N	N	N	Y
Diagnostic Menu	N	Y	Y	Y	Y	Y
Calibration Menu	N	N	N	N	N	Y
Lockout Menu						
$LoLo$	N	Y	Y	Y	Y	Y
$LoLP$	N	Y	Y	Y	Y	Y
$PAS.E$	N	Y	Y	Y	Y	Y
$rLoL$	Y	Y	Y	Y	Y	Y
$SLoL$	Y	Y	Y	Y	Y	Y

The following examples show how the Lockout Menu parameters may be used in applications:

1. You can lock out access to the Operations Page but allow an operator access to the Profile Menu, by changing the default Profile Page and Operations Page security levels. Change Lock Operations Page  $LoLo$  to 3 and Lock Profiling Page  $LoLP$  to 2. If Set Lockout Security  $SLoL$  is set to 2 or higher and the Read Lockout Security  $rLoL$  is set to 2, the Profiling Page and Home Pages can be accessed, and all writable parameters can be written to. Pages with security levels greater than 2 will be locked out (unaccessible).
2. If Set Lockout Security  $SLoL$  is set to 0 and Read Lockout Security  $rLoL$  is set to 5, all pages will be accessible, however, changes will not be allowed on any pages or menus, with one exception: Set Lockout Security  $SLoL$  can be changed to a higher level.
3. The operator wants to read all the menus and not allow any parameters to be changed.  
In the Factory Page, Lockout Menu, set Read Lockout Security  $rLoL$  to 5 and Set Lockout Security  $SLoL$  to 0.
4. The operator wants to read and write to the Home Page and Profiling Page, and lock all other pages and menus.  
In the Factory Page, Lockout Menu, set Read Lockout Security  $rLoL$  to 2 and Set Lockout Security  $SLoL$  to 2.  
In the Factory Page, Lockout Menu, set Lock Operations Page  $LoLo$  to 3 and Lock Profiling Page  $LoLP$  to 2.
5. The operator wants to read the Operations Page, Setup Page, Profiling Page, Diagnostics Menu, Lock Menu, Calibration Menu and Custom Menus. The operator also wants to read and write to the Home Page.

In the Factory Page, Lockout Menu, set Read Lockout Security  $rLoL$  to 1 and Set Lockout Security  $SLoL$  to 5.

In the Factory Page, Lockout Menu, set Lock Operations Page  $LoLo$  to 2 and Lock Profiling Page  $LoLP$  to 3.

## Using Password Security

It is sometimes desirable to apply a higher level of security to the control where a limited number of menus are visible and not providing access to others without a security password. Without the appropriate password those menus will remain inaccessible. If Password Enabled  $PAS.E$  in the Factory Page under the  $LoL$  Menu is set to on, an overriding Password Security will be in effect. When in effect, the only Pages that a User without a password has visibility to are defined in the Locked Access Level  $LoLL$  prompt. On the other hand, a User with a password would have visibility restricted by the Read Lockout Security  $rLoL$ . As an example, with Password Enabled and the Locked Access Level  $LoLL$  set to 1 and  $rLoL$  is set to 3, the available Pages for a User without a password would be limited to the Home and Factory Pages (locked level 1). If the User password is entered all pages would be accessible with the exception of the Setup Page as defined by level 3 access.

### How to Enable Password Security

Go to the Factory Page by holding down the Infinity  $\infty$  key and the Advance  $\rightarrow$  key for approximately six seconds. Once there, push the Down  $\downarrow$  key one time to get to the  $LoL$  menu. Again push the Advance  $\rightarrow$  key until the Password Enabled  $PAS.E$  prompt is visible. Lastly, push either the up or down key to turn it on. Once on, 4 new prompts will appear:

1.  $LoLL$ , Locked Access Level (1 to 5) corresponding to the lockout table above.
2.  $roLL$ , Rolling Password will change the Customer Code every time power is cycled.
3.  $PAS.u$ , User Password which is needed for a User to acquire access to the control.
4.  $PAS.A$ , Administrator Password which is needed to acquire administrative access to the control.

The Administrator can either change the User and or the Administrator password or leave them in the default state. Once Password Security is enabled they will no longer be visible to anyone other than the Administrator. As can be seen in the formula that follows either the User or Administrator will need to know what those passwords are to acquire a higher level of access to the control. Back out of this menu by pushing the Infinity  $\infty$  key. Once out of the menu, the Password Security will be enabled.

### How to Acquire Access to the Control

To acquire access to any inaccessible Pages or Menus, go to the Factory Page and enter the  $ULoL$  menu. Once there follow the steps below:

**Note:**

If Password Security (Password Enabled [PASS.E] is On) is enabled the two prompts mentioned below in the first step will not be visible. If unknown, call the individual or company that originally set-up the control.

1. Acquire either the User Password [PASS.U] or the Administrator Password [PASS.A].
2. Push the Advance [ADV] key one time where the Code [CODE] prompt will be visible.

**Note:**

- a. If the the Rolling Password is off push the Advance key one more time where the Password [PASS] prompt will be displayed. Proceed to either step 7a or 8a. Pushing the Up [UP] or Down [DN] arrow keys enter either the User or Administrator Password. Once entered, push and hold the Infinity [INF] key for two seconds to return to the Home Page.
- b. If the Rolling Password [ROLL] was turned on proceed on through steps 3 - 9.
3. Assuming the Public Key [CODE] prompt is still visible on the face of the control simply push the Advance key to proceed to the Password [PASS] prompt. If not find your way back to the Factory Page as described above.
4. Execute the calculation defined below (7b or 8b) for either the User or Administrator.
5. Enter the result of the calculation in the upper display by using the Up [UP] or Down [DN] arrow keys or use EZ-ZONE Configurator Software.
6. Exit the Factory Page by pushing and holding the Infinity [INF] key for two seconds.

Formulas used by the User and the Administrator to calculate the Password follows:

Passwords equal:

**7. User**

- a. If Rolling Password [ROLL] is Off, Password [PASS] equals User Password [PASS.U].
- b. If Rolling Password [ROLL] is On, Password [PASS] equals:  

$$((PASS.U) \times code) \text{ Mod } 929 + 70$$

**8. Administrator**

- a. If Rolling Password [ROLL] is Off, Password [PASS] equals User Password [PASS.A].
- b. If Rolling Password [ROLL] is On, Password [PASS] equals:  

$$((PASS.A) \times code) \text{ Mod } 997 + 1000$$

**Differences Between a User Without Password, User With Password and Administrator**

- User **without** a password is restricted by the Locked Access Level [LACL].

- A User **with** a password is restricted by the Read Lockout Security [rLoC] never having access to the Lock Menu [LoC].
- An Administrator is restricted according to the Read Lockout Security [rLoC] however, the Administrator has access to the Lock Menu where the Read Lockout can be changed.

# Chapter 10: Appendix

Troubleshooting Alarms, Errors and Control Issues			
Indication	Description	Possible Causes	Corrective Action
Alarm won't clear or reset	Alarm will not clear or reset with keypad or digital input	<ul style="list-style-type: none"> <li>Alarm latching is active</li> <li>Alarm set to incorrect output</li> <li>Alarm is set to incorrect source</li> <li>Sensor input is out of alarm set point range</li> <li>Alarm set point is incorrect</li> <li>Alarm is set to incorrect type</li> <li>Digital input function is incorrect</li> </ul>	<ul style="list-style-type: none"> <li>Reset alarm when process is within range or disable latching</li> <li>Set output to correct alarm source instance</li> <li>Set alarm source to correct input instance</li> <li>Correct cause of sensor input out of alarm range</li> <li>Set alarm set point to correct trip point</li> <li>Set alarm to correct type: process, deviation or power</li> <li>Set digital input function and source instance</li> </ul>
Alarm won't occur	Alarm will not activate output	<ul style="list-style-type: none"> <li>Alarm silencing is active</li> <li>Alarm blocking is active</li> <li>Alarm is set to incorrect output</li> <li>Alarm is set to incorrect source</li> <li>Alarm set point is incorrect</li> <li>Alarm is set to incorrect type</li> </ul>	<ul style="list-style-type: none"> <li>Disable alarm silencing, if required</li> <li>Disable alarm blocking, if required</li> <li>Set output to correct alarm source instance</li> <li>Set alarm source to correct input instance</li> <li>Set alarm set point to correct trip point</li> <li>Set alarm to correct type: process, deviation or power</li> </ul>
<u>ALF1</u> Alarm Error <u>ALF2</u> <u>ALF3</u> <u>ALF4</u>	Alarm state cannot be determined due to lack of sensor input	<ul style="list-style-type: none"> <li>Sensor improperly wired or open</li> <li>Incorrect setting of sensor type</li> <li>Calibration corrupt</li> </ul>	<ul style="list-style-type: none"> <li>Correct wiring or replace sensor</li> <li>Match setting to sensor used</li> <li>Check calibration of controller</li> </ul>
<u>ALL1</u> Alarm Low <u>ALL2</u> <u>ALL3</u> <u>ALL4</u>	Sensor input below low alarm set point	<ul style="list-style-type: none"> <li>Temperature is less than alarm set point</li> <li>Alarm is set to latching and an alarm occurred in the past</li> <li>Incorrect alarm set point</li> <li>Incorrect alarm source</li> </ul>	<ul style="list-style-type: none"> <li>Check cause of under temperature</li> <li>Clear latched alarm</li> <li>Establish correct alarm set point</li> <li>Set alarm source to proper setting</li> </ul>
<u>ALH1</u> Alarm High <u>ALH2</u> <u>ALH3</u> <u>ALH4</u>	Sensor input above high alarm set point	<ul style="list-style-type: none"> <li>Temperature is greater than alarm set point</li> <li>Alarm is set to latching and an alarm occurred in the past</li> <li>Incorrect alarm set point</li> <li>Incorrect alarm source</li> </ul>	<ul style="list-style-type: none"> <li>Check cause of over temperature</li> <li>Clear latched alarm</li> <li>Establish correct alarm set point</li> <li>Set alarm source to proper setting</li> </ul>
<u>Err1</u> Error Input	Sensor does not provide a valid signal to controller	<ul style="list-style-type: none"> <li>Sensor improperly wired or open</li> <li>Incorrect setting of sensor type</li> <li>Calibration corrupt</li> </ul>	<ul style="list-style-type: none"> <li>Correct wiring or replace sensor</li> <li>Match setting to sensor used</li> <li>Check calibration of controller</li> </ul>
Indication	Description	Possible Causes	Corrective Action

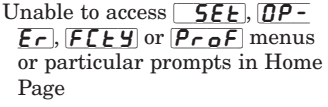

<p><b>[LPoI]</b> Loop Open Error</p>	<p>Open Loop Detect is active and the process value did not deviate by a user-selected value in a user specified period.</p>	<ul style="list-style-type: none"> <li>• Setting of Open Loop Detect Time incorrect</li> <li>• Setting of Open Loop Detect Deviation incorrect</li> <li>• Thermal loop is open</li> <li>• Open Loop Detect function not required but activated</li> </ul>	<ul style="list-style-type: none"> <li>• Set correct Open Loop Detect Time for application</li> <li>• Set correct Open Loop Deviation value for application</li> <li>• Determine cause of open thermal loop: misplaced sensors, load failure, loss of power to load, etc.</li> <li>• Deactivate Open Loop Detect feature</li> </ul>
<p><b>[LPri]</b> Loop Reversed Error</p>	<p>Open Loop Detect is active and the process value is headed in the wrong direction when the output is activated based on deviation value and user-selected value.</p>	<ul style="list-style-type: none"> <li>• Setting of Open Loop Detect Time incorrect</li> <li>• Setting of Open Loop Detect Deviation incorrect</li> <li>• Output programmed for incorrect function</li> <li>• Thermocouple sensor wired in reverse polarity</li> </ul>	<ul style="list-style-type: none"> <li>• Set correct Open Loop Detect Time for application</li> <li>• Set correct Open Loop Deviation value for application</li> <li>• Set output function correctly</li> <li>• Wire thermocouple correctly, (red wire is negative)</li> </ul>
<p><b>[rPi]</b> Ramping 1</p>	<p>Controller is ramping to new set point</p>	<ul style="list-style-type: none"> <li>• Ramping feature is activated</li> </ul>	<ul style="list-style-type: none"> <li>• Disable ramping feature if not required</li> </ul>
<p><b>[tunI]</b> Autotuning 1</p>	<p>Controller is autotuning the control loop</p>	<ul style="list-style-type: none"> <li>• User started the autotune function</li> <li>• Digital input is set to start autotune</li> </ul>	<ul style="list-style-type: none"> <li>• Wait until autotune completes or disable autotune feature</li> <li>• Set digital input to function other than autotune, if desired</li> </ul>
<p>No heat/cool action</p>	<p>Output does not activate load</p>	<ul style="list-style-type: none"> <li>• Output function is incorrectly set</li> <li>• Control mode is incorrectly set</li> <li>• Output is incorrectly wired</li> <li>• Load, power or fuse is open</li> <li>• Control set point is incorrect</li> <li>• Incorrect controller model for application</li> </ul>	<ul style="list-style-type: none"> <li>• Set output function correctly</li> <li>• Set control mode appropriately (Open vs Closed Loop)</li> <li>• Correct output wiring</li> <li>• Correct fault in system</li> <li>• Set control set point in appropriate control mode and check source of set point: remote, idle, profile, closed loop, open loop</li> <li>• Obtain correct controller model for application</li> </ul>
<p>No Display</p>	<p>No display indication or LED illumination</p>	<ul style="list-style-type: none"> <li>• Power to controller is off</li> <li>• Fuse open</li> <li>• Breaker tripped</li> <li>• Safety interlock switch open</li> <li>• Separate system limit control activated</li> <li>• Wiring error</li> <li>• Incorrect voltage to controller</li> </ul>	<ul style="list-style-type: none"> <li>• Turn on power</li> <li>• Replace fuse</li> <li>• Reset breaker</li> <li>• Close interlock switch</li> <li>• Reset limit</li> <li>• Correct wiring issue</li> <li>• Apply correct voltage, check part number</li> </ul>
<p>No Serial Communication</p>	<p>Cannot establish serial communications with the controller</p>	<ul style="list-style-type: none"> <li>• Address parameter incorrect</li> <li>• Incorrect protocol selected</li> <li>• Baud rate incorrect</li> <li>• Parity incorrect</li> <li>• Wiring error</li> <li>• EIA-485 converter issue</li> <li>• Incorrect computer or PLC communications port</li> <li>• Incorrect software setup</li> <li>• Termination resistor may be required</li> </ul>	<ul style="list-style-type: none"> <li>• Set unique addresses on network</li> <li>• Match protocol between devices</li> <li>• Match baud rate between devices</li> <li>• Match parity between devices</li> <li>• Correct wiring issue</li> <li>• Check settings or replace converter</li> <li>• Set correct communication port</li> <li>• Correct software setup to match controller</li> <li>• Place 120 Ω resistor across EIA-485 on last controller</li> </ul>

Indication	Description	Possible Causes	Corrective Action
Process doesn't control to set point	Process is unstable or never reaches set point	<ul style="list-style-type: none"> <li>• Controller not tuned correctly</li> <li>• Control mode is incorrectly set</li> <li>• Control set point is incorrect</li> </ul>	<ul style="list-style-type: none"> <li>• Perform autotune or manually tune system</li> <li>• Set control mode appropriately (Open vs Closed Loop)</li> <li>• Set control set point in appropriate control mode and check source of set point: remote, idle, profile, closed loop, open loop</li> </ul>
Temperature runaway	Process value continues to increase or decrease past set point.	<ul style="list-style-type: none"> <li>• Controller output incorrectly programmed</li> <li>• Thermocouple reverse wired</li> <li>• Controller output wired incorrectly</li> <li>• Short in heater</li> <li>• Power controller connection to controller defective</li> <li>• Controller output defective</li> </ul>	<ul style="list-style-type: none"> <li>• Verify output function is correct (heat or cool)</li> <li>• Correct sensor wiring (red wire negative)</li> <li>• Verify and correct wiring</li> <li>• Replace heater</li> <li>• Replace or repair power controller</li> <li>• Replace or repair controller</li> </ul>
 Device Error	Controller displays internal malfunction message at power up.	<ul style="list-style-type: none"> <li>• Controller defective</li> </ul>	<ul style="list-style-type: none"> <li>• Replace or repair controller</li> </ul>
Menus inaccessible	Unable to access  menus or particular prompts in Home Page	<ul style="list-style-type: none"> <li>• Security set to incorrect level</li> <li>• Digital input set to lockout keypad</li> <li>• Custom parameters incorrect</li> </ul>	<ul style="list-style-type: none"> <li>• Check lockout setting in Factory Page</li> <li>• Change state of digital input</li> <li>• Change custom parameters in Factory Page</li> </ul>
EZ-Key doesn't work	EZ-Key does not activate required function	<ul style="list-style-type: none"> <li>• EZ-Key function incorrect</li> <li>• EZ-Key function instance not incorrect</li> <li>• Keypad malfunction</li> </ul>	<ul style="list-style-type: none"> <li>• Verify EZ-Key function in Setup Menu</li> <li>• Check that the function instance is correct</li> <li>• Replace or repair controller</li> </ul>



# Specifications

## Line Voltage/Power (Minimum /Maximum Ratings)

- 85 to 264V~ (ac), 47 to 63Hz
- 20 to 28V~ (ac), 47 to 63Hz
- 12 to 40V= (dc)
- 14VA maximum power consumption (PM4, 8 & 9)
- 10VA maximum power consumption (PM3 & 6)
- Data retention upon power failure via nonvolatile memory
- Compliant with SEMIF47-0200, Figure R1-1 voltage sag requirements @24V ~ (ac) or higher

## Environment

- 0 to 149°F (-18 to 65°C) operating temperature
- 40 to 185°F (-40 to 85°C) storage temperature
- 0 to 90%RH, non-condensing

## Accuracy

- Calibration accuracy and sensor conformity: ±0.1% of span, ±1°C @ the calibrated ambient temperature and rated line voltage
- Types R, S, B; 0.2%
- Type T below -50°C; 0.2%
- Calibration ambient temperature @ 77 ±5°F (25±3°C)
- Accuracy span :1000 °F (540°C) min.
- Temperature stability: ±0.1 °F/°F (±0.1 °C/°C) rise in ambient maximum

## Agency Approvals

- UL® Listed to UL® 61010-1 File E185611
- UL® Reviewed to CSA C22.2 No.61010-1-04
- UL® 50Type4X,NEMA4X indoor locations, IP66 front panel seal
- FM Class 3545 File 3029084 temperature limit switches
- CE-See Declaration of Conformity RoHS and W.E.E.E.complaint
- This equipment is suitable for use in Class 1, Div.2, Groups A, B, C and D or non-hazardous locations only. Temperature Code T4A
- UL® Listed to ANSI/ISA 12.12.01-2007 File E184390
- PM3/6 CSA C22. No. 24 File 158031 Class 4813-02, both 1/32 and 1/16 DIN CSA approved
- UL® reviewed to Standard No. CSA C22.2 No.213-M1987, Canadian Hazardous locations

## Controller

- User selectable heat/cool, on-off, P, PI, PD, PID or alarm action
- Auto-tune with TRU-TUNE®+ adaptive control algorithm
- Control sampling rates: input = 10Hz, outputs = 10Hz

## Profile Ramp/Soak - Real Time Clock and Battery Back-up

- Accuracy (typical): ±30PPM at 77°F (25°C)
- +30/-100 PPM at -4 to 149°F (-20 to 65°C)
- Battery type: lithium (recycle properly)
- Battery typical life: three cumulative years of unpowered life at 77°F (25°C)

## Isolated Serial Communications

- EIA232/485, Modbus® RTU

## Wiring Termination—Touch-Safe Terminals

- Input, power and controller output terminals are touch safe re movable 3.30 to 0.0507 mm<sup>2</sup> (12 to 22 AWG)
- Wire strip length 7.6 mm (0.30 in.)
- Torque 0.8 Nm (7.0 lb.-in.)

## Universal Input

- Thermocouple, grounded or ungrounded sensors
- >20MΩ input impedance
- 3μA open sensor detection
- Max. of 2KΩ source resistance
- RTD 2 or 3 wire, platinum, 100Ω and 1000Ω @ 0°C calibration to DIN curve (0.00385Ω/Ω°C)
- Process, 0-20mA @ 100Ω , or 0-10V =(dc) @ 20kΩ input imped-

ance; scalable, 0-50mV, 0-1000Ω

- Potentiometer: 0 to 1,200Ω

- Inverse scaling

Input Type	Max Error @ 25 Deg C	Accuracy Range Low	Accuracy Range High	Units
J	±1.75	0	750	Deg C
K	±2.45	-200	1250	Deg C
T (0 to 350)	±1.55	0	350	Deg C
T (-200 to 0)	±1.55	-200	0	Deg C
N	±2.25	0	1250	Deg C
E	±2.10	-200	900	Deg C
R	±3.9	0	1450	Deg C
S	±3.9	0	1450	Deg C
B	±2.66	870	1700	Deg C
C	±3.32	0	2315	Deg C
D	±3.32	0	2315	Deg C
F (PTII)	±2.34	0	1343	Deg C
RTD, 100 ohm	±2.00	-200	800	Deg C
RTD, 1000 ohm	±2.00	-200	800	Deg C
mV	±0.05	0	50	mV
Volts	±0.01	0	10	Volts
mAdc	±0.02	0	20	mAmps DC
mAac	±5	-50	50	mAmps AC
Potentiometer, 1K range	±1	0	1000	Ohms
Thermistor, 5K range	±5	0	5000	Ohms
Thermistor, 10K range	±10	0	10000	Ohms
Thermistor, Thermistor	±20	0	20000	Ohms
Thermistor, 40K range	±40	0	40000	Ohms

## Operating Range

Input Type	Range Low	Range High
J	-210	1200
K	-270	1371
T	-270	400
N	-270	1300
E	-270	1000
R	-50	1767
S	-50	1767
B	-50	1816
C	0	2315
D	0	2315
F (PTII)	0	1343
RTD (100 ohm)	-200	800

Operating Range		
RTD (1000 ohm)	-200	800
mV	-50	50
Volts	0	10
mAdc	0	20
mAac	-50	50
Potentiometer, 1K range	0	1200
Resistance, 5K range	0	5000
Resistance, 10K range	0	10000
Resistance, 20K range	0	20000
Resistance, 40K range	0	40000

### Thermistor Input

- 0 to 40K $\Omega$ , 0 to 20K $\Omega$ , 0 to 10K $\Omega$ , 0 to 5K $\Omega$
- 2.252K $\Omega$  and 10K $\Omega$  base at 77°F (25°C)
- Linearization curves built in
- Third party Thermistor compatibility requirements

Base R @ 25C	Alpha Techniques	Beta THERM	YSI	Prompt E,C
2.252K	Curve A	2.2K3A	004	A
10K	Curve A	10K3A	016	B
10K	Curve C	10K4A	006	C

### 2 Digital Input/Output Option - 2 DIO

- Digital input update rate 10Hz
  - DC voltage
    - Max. input 36V @ 3mA
    - Min. high state 3V at 0.25mA
    - Max. low state 2V
  - Dry contact
    - Min. open resistance 10K $\Omega$
    - Max. closed resistance 50 $\Omega$
    - Max. short circuit 20mA
- Digital output update rate 10Hz
  - Output voltage 24V, current limit, Output 6 = 10mA max., Output 5 = 3 pole DIN-A-MITE<sup>®</sup> or 24mA max.

### Output Hardware

- Switched dc = 22 to 32V $\overline{=}$  (dc) @ 30mA
- Switched dc/open collector = 30V $\overline{=}$  (dc) max. @ 100mA max. current sink
- Solid state relay (SSR), FormA, 0.5A @ 24V $\sim$  (ac) min., 264V $\sim$  (ac) max., opto-isolated, without contact suppression, 20 VA 120/240V $\sim$  (ac) pilot duty
- Electromechanical relay, FormC, 5A, 24 to 240V $\sim$  (ac) or 30V $\overline{=}$  (dc) max., resistive load, 100,000 cycles at rated load, 125 VA pilot duty at 120/240V $\sim$  (ac), 25 VA at 24V $\sim$  (ac)
- Electromechanical relay, FormA, 5A, 24 to 240V $\sim$  (ac) or 30V $\overline{=}$  (dc) max., resistive load, 100,000 cycles at rated load, 125 VA pilot duty at 120/240V $\sim$  (ac), 25 VA at 24V $\sim$  (ac)
- NO-ARC relay, FormA, 15A, 24 to 240V $\sim$  (ac), noV $\overline{=}$  (dc), resistive load, 2 million cycles at rated load
- Universal process/retransmit, Output range selectable:
  - 0 to 10V $\overline{=}$ (dc) into a min. 1,000 $\Omega$  load
  - 0 to 20mA into max. 800 $\Omega$  load

### Operator Interface

- Dual 4 digit, 7 segment LED displays
- Advance, infinity, up and down keys, plus optional programmable EZ-KEY(s) depending on model size
- Typical display update rate 1Hz
- RESET key substituted for infinity on all models including the limit control

### Dimensions

Dimensions				
Size	Behind Panel (max.)	Width	Height	Display Character Height
1/32	101.6 mm (4.00 in)	53.3 mm (2.10 in)	30.9 mm (1.22 in)	left: 7.59 mm (0.299 in) right: 5.90 mm (0.220 in)
1/4	100.8 mm (3.97 in)	100.3 mm (3.95 in)	100.3 mm (3.95 in)	up: 11.43 mm (0.450 in) middle: 9.53 mm (0.375 in) low: 7.62 mm (0.300 in)
1/16	101.6 mm (4.00 in)	53.3 mm (2.10 in)	53.3 mm (2.10 in)	up: 10.80 mm (0.425 in) low: 6.98 mm (0.275 in)
1/8 (H)	101.6 mm (4.00 in)	100.3 mm (2.10 in)	53.9 mm (1.22 in)	top: 11.4 mm (0.450 in) middle: 9.53 mm (0.375 in) bottom: 7.62 mm (0.300 in)
1/8 (V)	101.6 mm (4.00 in)	53.3 mm (2.10 in)	100.3 mm (3.95 in)	top: 11.4 mm (0.450 in) middle: 9.53 mm (0.375 in) bottom: 7.62 mm (0.300 in)

Weight	
1/32 DIN (PM3) • Controller: 127 g (4.5 oz.)	1/8 DIN (PM8&9) • Controller: 284 g (10 oz.)
1/16 DIN (PM6) • Controller: 186 g (6.6 oz.)	1/4 DIN (PM4) • Controller: 331 g (11.7 oz.)
User Manual • User manual: 221.81 g (7.82 oz)	

Modbus<sup>®</sup> is a trademark of AEG Schneider Automation Inc.

EtherNet/IP<sup>™</sup> is a trademark of ControlNet International Ltd. used under license by Open DeviceNet Vendor Association, Inc. (ODVA).

UL<sup>®</sup> is a registered trademark of Underwriters Laboratories Inc.

DeviceNet<sup>™</sup> is a trademark of Open DeviceNet Vendors Association.

### Note:

These specifications are subject to change without prior notice.

# Ordering Information for PID Controller Models

## Controller

EZ-ZONE® PID Controller Models  
 TRU-TUNE+® Adaptive Tune, red-green 7-segment displays

P M - A A A A

## Package Size

- 3 Panel Mount 1/32 DIN
- 6 Panel Mount 1/16 DIN
- 8 Panel Mount 1/8 DIN Vertical
- 9 Panel Mount 1/8 DIN Horizontal
- 4 Panel Mount 1/4 DIN Horizontal

## Primary Function

- C PID Controller with Universal Input
- R PID Controller with Universal Input and Profiling Ramp and Soak
- B PID Controller with Universal Input and Profiling Ramp and Soak and Battery Backup with Real Time Clock
- J PID Controller with Thermistor Input
- N PID Controller with Thermistor Input and Profiling Ramp and Soak
- E PID Controller with Thermistor Input and Profiling Ramp and Soak and Battery Backup with Real Time Clock
- S Custom Firmware

- Options B and E are not available with PM3 or PM6

## Power Supply, Digital Input/Output

- 1 100 to 240V~ (ac)
- 2 100 to 240V~ (ac) plus 2 Digital I/O points
- 3 15 to 36V= (dc) and 24V~ (ac)
- 4 15 to 36V= (dc) and 24V~ (ac), plus 2 Digital I/O points

## Output 1 and 2 Hardware Options

Output 1		Output 2
CA	Switched dc/open collector	None
CH	Switched dc/open collector	NO-ARC 15 A power control
CC	Switched dc/open collector	Switched dc
CJ	Switched dc/open collector	Mechanical relay 5 A, form A
CK	Switched dc/open collector	Solid-State Relay 0.5 A, form A
EA	Mechanical relay 5 A, form C	None
EH	Mechanical relay 5 A, form C	NO-ARC 15 A power control
EC	Mechanical relay 5 A, form C	Switched dc
EJ	Mechanical relay 5 A, form C	Mechanical relay 5 A, form A
EK	Mechanical relay 5 A, form C	Solid-State Relay 0.5 A, form A
FA	Universal process	None
FC	Universal process	Switched dc (cannot use variable time base)
FJ	Universal process	Mechanical relay 5 A, form A (cannot use variable time base)
FK	Universal process	Solid-State Relay 0.5 A, form A (cannot use variable time base)
AK	None	Solid-State Relay 0.5 A, form A
KH	Solid-State Relay 0.5 A, form A	NO-ARC 15 A power control
KK	Solid-State Relay 0.5 A, form A	Solid-state relay 0.5 A, form A

- Options CH, EH and KH are not available with PM3 (1/32 DIN)

## Communications Options

- A None
- 1 EIA 485 Modbus RTU®

- Standard Bus EIA-485 always included - all models

## Future Options

- AAAA None

## Custom Options

- AA Standard EZ-ZONE face plate
- 12 Class 1, Div. 2 (Not available with mechanical relay output types E, H, J)

# Index

- AbL** Alarm Blocking 57, 84
- ACLF** AC Line Frequency 59, 83
- AdL** Alarm Delay 58
- AdSP** Alarm Display 58
- Ah** Alarm High Set Point 36, 84
- AHy** Alarm Hysteresis 57, 84
- A** Analog Input Menu 31, 43
- A.S** Alarm Source Instance 56
- ALA** Alarm Latching 57, 84
- ALe1** **ALe2** **ALe3** **ALe4**  
Alarm Error 1 to 4 24
- AL9** Alarm Logic 57
- ALh1** **ALh2** **ALh3** **ALh4**  
Alarm High 1 to 4 24
- ALh1** **ALh2** **ALh3** **ALh4**  
Alarm High 1 to 4 24
- ALL1** **ALL2** **ALL3** **ALL4**  
Alarm Low 1 to 4 24
- ALL1** **ALL2** **ALL3** **ALL4**  
Alarm Low 1 to 4 24
- ALL1** **ALL2** **ALL3** **ALL4**  
Alarm Low 1 to 4 24
- ALM** Alarm Menu 36, 56
- ALo** Alarm Low Set Point 36, 84
- ASd** Alarm Sides 57
- AS** Alarm Silencing 58, 84
- ATP** Absolute Temperature 45
- Autotune** Set Point 34, 75
- Att** Attention 24, 25, 84
- Aty** Alarm Type 56, 83
- Aut** Altitude Units 47
- Autotune** 34, 75
- bPLS** 80
- CA9** Cool Algorithm 51, 81
- CAL** Calibration Menu 72
- CCr** Cool Output Curve 51, 80
- C.F** Display Units 59
- Chan** Channel 61
- Chy** Cool Hysteresis 35, 81
- CLED** Communications LED Activity 60
- CLoC** Wait for Time 65
- CLR** Clear 84
- CM** Control Mode 34, 80
- CMa** Control Mode Active 33
- Code** Public Key 68, 71
- CoM** Communications Menu 61, 62, 65, 69
- CPb** Cool Proportional Band 35, 76, 81
- CP** Cool Power 33, 76
- CSP** Closed Loop Set Point 34
- CSP** Closed Loop Working Set Point 34
- CUSE** Custom Menu 25, 75
- dATE** Date of Manufacture 72
- db** Dead Band 35, 82
- diO** Digital Input/Output Menu 33, 48
- dir** Direction 48
- doS** Digital Output State 33
- doWd** Day of Week 63
- dPrS** Display Pairs 42, 61
- dt** Display Time 61
- E.S** Event Input Status 33
- ELo** Electrical Input Offset 72, 77
- EL.S** Electrical Input Slope 72, 77
- ELoO** Electrical Output Offset 72
- Ent1** Active Event Output 1 39
- Ent2** Event Output 2 67
- Er.1** **Er.2** Error Input 1 or 2 24
- Er.1** Error Input 1 24
- FAIL** Input Error Failure 52, 80
- F** Digital Output Function Instance 48, 50
- F** Output Function Instance 54, 55
- FiL** Filter 45
- FiL** Filter Time 78
- Fn** Output Function 54, 55
- Fn** Function 47
- FUn** Function Key Menu 58
- GLbL** Global Menu 59
- 95d** Guaranteed Soak Deviation 60
- 95d1** Guaranteed Soak Deviation 1 60
- 95E** Guaranteed Soak Enable 60
- 95E** Guaranteed Soak Enable 60
- 95E** Guaranteed Soak Enable 60
- hA9** Heat Algorithm 50, 81
- hhY** Heat Hysteresis 35, 81
- hoUr** 62
- hoUr** Hours 62
- hPb** Heat Proportional Band 35, 76, 81
- hPr** Heat Power 33, 76
- .iCA** Calibration Offset 31, 77–78
- .iS** Idle Set Point 34
- .iEr** Input Error Latching 45
- .iEr** Input Error Status 31
- .iP.1** Input Point 1 45
- .iP.2** Input Point 2 45
- .iP.3** Input Point 3 46
- .iP.4** Input Point 4 46
- .iP.5** Input Point 5 45, 46
- .iP.6** Input Point 6 46
- .iP.7** Input Point 7 46
- .iP.8** Input Point 8 46
- .iP.9** Input Point 9 47
- .iP.10** Input Point 10 47
- .iPF4** IP Fixed Address Part 4 60, 61
- JC** Jump Count Remaining 39
- JS** Jump Step 66
- Ldd** Open Loop Detect Deviation 53
- LdE** Open Loop Detect Enable 52
- Ldt** Open Loop Detect Time 52
- L.M** Limit Menu 33
- Lin** Linearization 43
- LLS** Limit Low Set Point 33
- Lnr** Linearization Menu 31, 45
- LoC** Security Setting Menu 70, 71
- LoCL** Locked Access Level 86
- LoCL** Locked Access Level 68, 70
- LoCo** Lock Operations Page 69, 70, 85
- LoCP** Lock Profiling Page 70, 71, 85
- Loop** Control Loop Menu 50
- Loop** Loop Menu 34
- LP.o1** Loop Open Error 24
- LP.o1** Loop Open Error 1 24
- LP.r1** Loop Reversed Error 24
- LP.r1** Loop Reversed Error 1 24
- r7An** 80
- r7An** Manual Power 52
- r7AP** Data Map 28
- r7.in** Minutes 62
- r7on** Monitor Menu 33
- r7u** Electrical Measurement 72, 77
- nUS** Non-volatile Save 62
- .oCA** Calibration Offset 56
- .oCt** Output Control 48, 54
- .oFn** Output Function 76, 79
- .oFSt** PV Offset 32
- .oh** Output High Power Scale 49, 55
- .oLo** Output Low Power Scale 49, 54
- .oP** Open Loop Set Point 36
- .oP.2** Output Point 2 45
- .oP.3** Output Point 3 46
- .oP.4** Output Point 4 46
- .oP.5** Output Point 5 46
- .oP.6** Output Point 6 46
- .oP.7** Output Point 7 46
- .oP.8** Output Point 8 47
- .oP.9** Output Point 9 47
- .oP.10** Output Point 10 47
- .otb** Output Time Base 49, 54
- .otPt** Output Menu 54
- .oty** Output Type 55, 79

**PASSA**, Administrator Password 86  
**PASSA** Administrator Password 68, 71  
**PASSE** Password Enable 68, 70  
**PASS** Password 71  
**PASS** Password 68  
**PASU**, User Password 86  
**PASU** User Password 68, 71  
**PdL** Peltier Delay 51  
**PEE** Process Error Enable 44  
**PEL** Process Error Low 44  
**Pn** Part Number 71  
**Pot**, Power Out Time 42  
**Pro** Process 45  
**PSA** Profile Status Menu 37  
**PtYP** Profile Type 60  
**Punt** Pressure Units 47  
**Pv** Process Value Menu 47  
**PvA** Process Value Active 34  
**REN** Remote Enable 34  
**REU** Software Revision 71  
**rhi** Range High 44, 56, 78  
**rh** Relative Humidity 45  
**rLo** Range Low 44, 56, 78  
**rLoC** Read Lockout Security 70, 85  
**roLL**, Rolling Password 86  
**roLL** Rolling Password 68, 71  
**rP** Ramp Action 53, 83  
**rPI** Ramping 24  
**rPI** Ramping 1 24  
**rPI** **rP2** Ramping 1 or 2 24  
**rRt** Ramp Rate 53, 83  
**rr** Thermistor Resistance Range 44  
**rSC** Ramp Scale 53, 83  
**rSr** Retransmit Source 79  
**rTL** RTD Leads 43  
**rTP** Relative Temperature 45  
**rTYP** Ramping Type 60  
**SbLd** Software Build 71  
**SEn** Sensor Type 43, 76, 78  
**SFnA** Source Function A 56  
**Shi** Scale High 44, 55, 78, 79  
**SiA** Event Input Source Instance A 60  
**SiB** Event Input Source Instance B 60  
**SiL** Silence 84  
**SLo** Scale Low 43, 55, 78, 79  
**SLoC** Set Lockout Security 70, 85, 86  
**Sn** Serial Number 72  
**St**, Step Time Remaining 39  
**STP** Active Step 38  
**STYP** Active Step Type 38  
**SvA** Source Value A 32  
**TAgR** User Tune Aggressiveness 51, 75

**tband** TRU-TUNE+™ Band 51, 76  
**tC** Thermistor Curve 44  
**tD** Time Derivative 35, 76, 82  
**tgn** TRU-TUNE+™ Gain 51, 76  
**tI** Time Integral 35, 76, 81  
**tTUN** TRU-TUNE+™ Enable 51, 76  
**tUn1** Tuning 24  
**tUn1** **tUn2** Tuning 1 or 2 24  
**tUn1** Tuning 1 24  
**UFA** User Failure Action 52  
**ULoC** Unlock Menu 86  
**USrR** User Restore Set 61, 75  
**USrS** User Save Set 61, 75  
**WJE2** Wait Event 2 66  
**Zone** Zone 60

## A

Absolute Temperature 45  
AC Line Frequency 59, 83  
Active Event Output (1 or 2) 39  
Active Step 38  
Active Step Type 38  
adaptive tuning 76  
Address Modbus 61  
Address Standard Bus 61, 62  
Administrator Password 68, 71  
agency approvals 2  
alarm blocking 84  
Alarm Menu 36, 56  
alarms 83  
  Blocking 57, 84  
  deviation 83  
  Display 58  
  Hysteresis 57, 84  
  Latching 57, 84  
  Logic 57  
  process 83  
  set points 83  
  Sides 57  
  Silencing 58, 84  
  Source 56  
  Type 56  
Alarm Type 83  
Altitude Units 41  
Analog Input Menu 31, 43  
Attention Codes 25  
auto (closed loop) control 80  
Autotune 75  
Autotune Aggressiveness 51  
Autotune Request 34  
Autotune Set Point 34, 75  
autotuning 75–76  
autotuning with TRU-TUNE+™ 76

## B

Baud Rate 62  
Blocking 57, 84  
bumpless transfer 80

## C

calibrating an analog input 77  
Calibration Menu 72  
Calibration Offset 31, 56, 77–78  
changing the set point 25  
Channel 61  
chattering output 81  
chemical compatibility 11  
Closed Loop Set Point 34  
Closed Loop Working Set Point 34  
Communications Menu 61, 62, 65, 69  
  Setup Page 30, 41  
Control 48, 54  
Control Loop Menu 50  
control methods 80  
Control Mode 34, 80  
Control Mode Active 33  
Control Module Menus  
  Factory Page  
    Calibration Menu 72  
    Security Setting Menu 70, 71  
  Operations Page  
    Alarm Menu 36  
    Analog Input Menu 31  
    Digital Input/Output Menu 33  
    Limit Menu 33  
    Linearization Menu 31  
    Loop Menu 34  
    Monitor Menu 33  
    Process Value Menu 32  
    Profile Status Menu 37  
  Setup Page  
    Alarm Menu 56  
    Analog Input Menu 43  
    Communications Menu 61, 62, 65, 69  
    Control Loop Menu 50  
    Digital Input/Output Menu 48  
    Global Menu 59  
    Linearization Menu 45  
    Output Menu 54  
    Process Value 47  
Cool Algorithm 51, 81  
Cool Hysteresis 35, 81  
Cool Output Curve 51, 80  
Cool Power 33, 76  
Cool Proportional Band 35, 76, 81  
Custom Menu 75

## D

Data Map 28, 62  
Date of Manufacture 72  
dead band 82  
Dead Band 35, 82  
default Home Page parameters 23, 25  
deviation alarms 83  
Digital Input Function 3, 59



Digital Input/Output Menu 33, 48  
digital inputs 3  
dimensions 7, 9  
    1/16 DIN 6  
    1/32 DIN 5  
Direction 48  
Display 58  
Display Pairs 42, 61  
displays 23  
Display Time 61  
Display Units 59  
Down Key 23

## E

Electrical Gain 77  
Electrical Input Offset 72, 77  
Electrical Input Slope 72, 77  
Electrical Measurement 72, 77  
Electrical Output Offset 72  
Electrical Output Slope 73  
End Set Point Value 67  
Event Output (1 and 2) 67  
EZ Key 84

## F

Factory Page 68  
Filter Time 45, 78  
filter time constant 78  
Function 41, 76  
Function Instance 48, 50  
Function Key Menu 84

## G

Global Menu 59  
    Setup Page 30, 41  
Guaranteed Soak Devia-  
    tion 42  
Guaranteed Soak Deviation 60  
Guaranteed Soak Enable 42, 60

## H

Heat Algorithm 50, 81  
Heat Hysteresis 35, 81  
Heat Power 33, 76  
Heat Proportional Band 35, 76, 81  
High Power Scale 49, 55  
high range 78  
high scale 78  
High Set Point  
    Alarm 36, 37, 84  
    Loop 53, 78  
Home Page 25, 75  
Hours 65  
Hysteresis 57, 84

## I

Idle Set Point 34  
Input Error Failure 52, 80  
Input Error Latching 45, 80  
Input Error Status 31  
input events 3

input features 77–79  
    calibration 77  
Input Point 1 41  
Input Point 2 41  
Input Point 3 41  
Input Point 4 41  
Input Point 5 41  
Input Point 6 41  
Input Point 7 41  
Input Point 8 41  
Input Point 9 41  
Input Point 10 41  
inputs 3  
Input Sensor Type 76  
installation 10  
Instance 59  
IP Fixed Address Part 4 60, 61

## J

Jump Count 67  
Jump Count Remaining 39, 40  
Jump Step 66

## K

keys and displays  
    1/16 DIN 23

## L

Latching 57, 84  
Level 58  
Limit Menu 33  
Linearization 28, 41, 43  
Linearization Menu 31, 45  
Locked Access Level 68, 70  
Lock Operations Page 85  
Lockout Menu 85  
Lock Profiling Page 85  
Logic 57  
Loop Menu 34  
Low Power Scale 49, 54  
low range 78  
low scale 78  
Low Set Point  
    Alarm 36, 84  
    Limit 33  
    Loop 53, 78

## M

Manual Control Indicator Light 80  
manual (open loop) control 80  
manual tuning 76  
Message Action 24  
message, display 24  
Minutes 65  
Modbus Word Order 62  
Monitor Menu 33

## N

navigating  
    Factory Page 68  
    pages and menus 27

Profiling Page 64  
    Setup Page 30, 41  
network wiring 21  
no-arc relay 79  
Non-volatile Save 42

## O

on-off control 81  
Open Loop Detect Deviation 53  
Open Loop Detect Enable 52  
Open Loop Detect Time 52  
Open Loop Set Point 36  
Operations Page 30  
output configuration 80  
output events 3  
output features 78  
Output Function 55, 79  
Output Menu 54  
Output Point 1 41  
Output Point 2 41  
Output Point 3 41  
Output Point 4 41  
Output Point 5 41  
Output Point 6 41  
Output Point 7 41  
Output Point 8 41  
Output Point 9 41  
Output Point 10 41  
output power scaling 79  
outputs 3  
Output State 33  
Output Type 55, 79

## P

P3T armor sealing system 2  
Parameter 1 to 20 69  
Parity 62  
Part Number 71  
Password 71  
Password Enable 68  
Peltier Delay 41, 51  
Power Out Time 42, 60  
Pressure Units 41  
process alarms 83  
Process Error Enable 44  
Process Error Low 44  
Process Value 31, 41, 47  
Process Value Active 34  
Process Value Menu 32  
Profibus 29  
Profile Status Menu 37  
Profile Type 60  
Profiling Page 64  
profiling parameters 64  
programming the Home Page 75  
proportional control 81  
    plus integral (PI) control 81  
    plus integral plus derivative (PID)  
        control 82  
Protocol 61

Public Key 68, 71

## Q

## R

Ramp Action 53  
Ramp Rate 53, 83  
Ramp Scale 53, 83  
Range High 44, 56, 78  
Range Low 44, 56, 78  
Read Lockout Security 85  
Real Time Clock 28, 42  
Relative Humidity 45  
Relative Temperature 45  
Remote Enable 34  
removing mounted controller 10  
responding to a displayed message  
24–25  
restoring user settings 75  
retransmit 78  
Retransmit Source 55, 79  
Rolling Password 68, 71  
RTD Leads 43

## S

saving user settings 75  
Scale High 44, 55, 78, 79  
Scale Low 43, 55, 78, 79  
Seconds 66  
secure settings 74, 85, 86  
Security Setting 70, 71  
sensor selection 78  
Sensor Type 43, 76, 78  
Serial Number 72  
Set Lockout Security 85  
set point high limit 78  
Set Point High Limit Open Loop 53  
set point low limit 78  
Set Point Low Limit Open Loop 53  
Setup Page 41  
Sides  
Alarm 57  
Silencing 58, 84  
single set point ramping 83  
Software Build 71  
Software Revision 71  
Source 56  
Step Time Remaining 39  
System Security 74, 86

## T

Target Set Point 65  
temperature units indicator lights 23  
Thermistor 16, 43  
Time Base 49, 54  
Time Derivative 35, 76, 82  
Time Integral 35, 76, 81  
TRU-TUNE+™ Band 51, 76  
TRU-TUNE+™ Enable 51, 76

TRU-TUNE+™ Gain 51, 76  
tuning the PID parameters 75  
Type 56

## U

upper display 23  
User Failure Action 52  
User Password 68, 71  
User Restore Set 61, 75  
User Save Set 61, 75  
User Tune Aggressiveness 75  
using the software 85

## V

variable time base 82

## W

Wait Event (1 and 2) 66  
Wait For Process Instance 66  
Wait For Time 65  
weight 92  
wiring  
digital input or output 5 14  
high power 14  
input 1 potentiometer 15  
input 1 process 15  
input 1 RTD 15  
input 1 thermocouple 15  
input 2 thermocouple 16  
low power 14  
Modbus RTU or Standard Bus EIA-  
485 communications 21  
output 1 mechanical relay, form C  
17  
output 1 solid-state relay, form A  
18  
output 1 switched dc/open collec-  
tor 17  
output 1 universal process 18  
output 2 mechanical relay, form  
A 19  
output 2 no-arc relay, form A 19  
output 2 solid-state relay, form A  
19  
output 2 switched DC/open collec-  
tor 18  
output 3 switched dc/open collec-  
tor 21  
Standard Bus EIA-485 communica-  
tions 21

## X

## Y

## Z

Zone Display 61



# Declaration of Conformity

## Series EZ-ZONE® PM



WATLOW  
1241 Bundy Blvd.  
Winona, MN 55987 USA

an ISO 9001 approved facility since 1996.

Declares that the following product:

Designation: **Series EZ-ZONE® PM (Panel Mount)**  
Model Numbers: PM (3, 6, 8, 9 or 4)(Any Letter or number) – (1, 2, 3 or 4)(A, C, E, F or K) (A, C, H, J or K)(Any letter or number) – (Any letter or number)(A, C, E, F or K)(A, C, H, J or K) (Any three letters or numbers)  
Classification: Temperature control, Installation Category II, Pollution degree 2, IP66  
Rated Voltage and Frequency: 100 to 240 V~ (ac 50/60 Hz) or 15 to 36 V= dc/ 24 V~ac 50/60 Hz  
Rated Power Consumption: 10 VA maximum PM3, PM6 Models.  
14 VA maximum PM8, PM9, PM4 Models

Meets the essential requirements of the following European Union Directives by using the relevant standards show below to indicate compliance.

### **2004/108/EC Electromagnetic Compatibility Directive**

<b>EN 61326-1</b>	<b>2006</b>	<b>Electrical equipment for measurement, control and laboratory use – EMC requirements (Industrial Immunity, Class B Emissions).</b>
EN 61000-4-2	1996 +A1,A2	Electrostatic Discharge Immunity
EN 61000-4-3	2006	Radiated Field Immunity 10V/M 80–1000 MHz, 3 V/M 1.4–2.7 GHz
EN 61000-4-4	2004	Electrical Fast-Transient / Burst Immunity
EN 61000-4-5	2006	Surge Immunity
EN 61000-4-6	1996 +A1,A2,A3	Conducted Immunity
EN 61000-4-11	2004	Voltage Dips, Short Interruptions and Voltage Variations Immunity
EN 61000-3-2	2006	Harmonic Current Emissions
EN 61000-3-3 <sup>1</sup>	2005	Voltage Fluctuations and Flicker
SEMI F47	2000	Specification for Semiconductor Sag Immunity Figure R1-1

<sup>1</sup>For mechanical relay loads, cycle time may need to be extended up to 160 seconds to meet flicker requirements depending on load switched and source impedance.

### **2006/95/EC Low-Voltage Directive**

<b>EN 61010-1</b>	<b>2001</b>	<b>Safety Requirements of electrical equipment for measurement, control and laboratory use. Part 1: General requirements</b>
-------------------	-------------	--

### **Compliant with 2002/95/EC RoHS Directive**

Per 2002/96/EC W.E.E Directive  Please Recycle Properly.

Raymond D. Feller III  
Name of Authorized Representative

Winona, Minnesota, USA  
Place of Issue

General Manager  
Title of Authorized Representative

June 2009  
Date of Issue

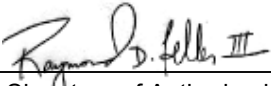
  
Signature of Authorized Representative

CE DOC EZ-ZONE PM-06-09

# How to Reach Us

## Corporate Headquarters

Watlow Electric Manufacturing Company  
12001 Lackland Road  
St. Louis, MO 63146  
Sales: 1-800-WATLOW2  
Manufacturing Support: 1-800-4WATLOW  
Email: info@watlow.com  
Website: www.watlow.com  
From outside the USA and Canada:  
Tel: +1 (314) 878-4600  
Fax: +1 (314) 878-6814

## Latin America

Watlow de México S.A. de C.V.  
Av. Fundación No. 5  
Col. Parques Industriales  
Querétaro, Qro. CP-76130  
Mexico  
Tel: +52 442 217-6235  
Fax: +52 442 217-6403

## Europe

Watlow France SARL  
Immeuble Somag  
16, Rue Ampère  
95307 Cergy-Pontoise CEDEX  
France  
Tel: + 33 (0)1 30 73 24 25  
Fax: + 33 (0)1 30 73 28 75  
Email: info@watlow.fr  
Website: www.watlow.fr

Watlow GmbH  
Postfach 11 65, Lauchwasenstr. 1  
D-76709 Kronau  
Germany  
Tel: +49 (0) 7253 9400-0  
Fax: +49 (0) 7253 9400-900  
Email: info@watlow.de  
Website: www.watlow.de

Watlow Italy S.r.l.  
Viale Italia 52/54  
20094 Corsico MI  
Italy  
Tel: +39 024588841  
Fax: +39 0245869954  
Email: italyinfo@watlow.com  
Website: www.watlow.it

Watlow Ibérica, S.L.U.  
C/Marte 12, Posterior, Local 9  
E-28850 Torrejón de Ardoz  
Madrid - Spain  
T. +34 91 675 12 92  
F. +34 91 648 73 80  
Email: info@watlow.es  
Website: www.watlow.es

Watlow UK Ltd.  
Linby Industrial Estate  
Linby, Nottingham, NG15 8AA  
United Kingdom  
Telephone: (0) 115 964 0777  
Fax: (0) 115 964 0071  
Email: info@watlow.co.uk  
Website: www.watlow.co.uk  
From outside The United Kingdom:  
Tel: +44 115 964 0777  
Fax: +44 115 964 0071

## Asia and Pacific

Watlow Singapore Pte Ltd.  
16 Ayer Rajah Crescent,  
#06-03/04,  
Singapore 139965  
Tel: +65 6773 9488 Fax: +65 6778 0323  
Email: info@watlow.com.sg Website: www.watlow.com.sg

Watlow Australia Pty., Ltd.  
4/57 Sharps Road  
Tullamarine, VIC 3043  
Australia  
Tel: +61 3 9335 6449  
Fax: +61 3 9330 3566  
Website: www.watlow.com

Watlow Electric Manufacturing (Shanghai) Company  
1118 Fangyuan Road, Anting Industrial Park, Jiading, Shanghai, PRC  
201203  
People's Republic of China  
Tel: +86 21 39509510 Fax: +86 21 5080-0906  
Email: info@watlow.cn Website: www.watlow.cn

ワトロー・ジャパン株式会社  
〒101-0047 東京都千代田区内神田1-14-4  
四国ビル別館9階  
Tel: 03-3518-6630 Fax: 03-3518-6632  
Email: infoj@watlow.com Website: www.watlow.co.jp

Watlow Japan Ltd.  
1-14-4 Uchikanda, Chiyoda-Ku  
Tokyo 101-0047  
Japan  
Tel: +81-3-3518-6630 Fax: +81-3-3518-6632  
Email: infoj@watlow.com Website: www.watlow.co.jp

Watlow Korea Co., Ltd.  
#1406, E&C Dream Tower, 46, Yangpyeongdong-3ga  
Yeongdeungpo-gu, Seoul 150-103  
Republic of Korea  
Tel: +82 (2) 2628-5770 Fax: +82 (2) 2628-5771  
Website: www.watlow.co.kr

Watlow Malaysia Sdn Bhd  
No. 14-3 Jalan 2/114  
Kuchai Business Centre  
Jalan Kuchai Lama  
58200 Kuala Lumpur  
Malaysia  
Tel: +60 3 7980 7741 Fax: +60 3 7980 7739

瓦特龍電機股份有限公司  
80143 高雄市前金區七賢二路189號 10樓之一  
電話: 07-2885168 傳真: 07-2885568

Watlow Electric Taiwan Corporation  
10F-1 No.189 Chi-Shen 2nd Road Kaohsiung 80143  
Taiwan  
Tel: +886-7-2885168 Fax: +886-7-2885568

## Your Authorized Watlow Distributor



20090610